



## SURGICAL CATALOGUE

We are manufacturer of Surgical Instruments. We use high quality material. Elifit Instruments customized sizes and different raw material can be used upon the request of customers. All our products will be CE mark. Our high skilled professional workers are able to make different kind of surgical instruments with best workmanship.

## Diagnostics



Buck  
EF-1-102-18  
20cm,



Buck  
EF-1-101-18  
Percussion Hammer  
18.5 cm,



Dejerine  
EF-1-103-20  
Percussion Hammer  
20cm,



Dejerine  
EF-1-104-21  
Percussion Hammer  
21cm,



Taylor Mod. USA  
EF-1-105-20  
Percussion Hammer  
20cm,



Wartenberg  
EF-1-106-19  
Pinwheel  
18cm,

## Diagnostics



Pinard  
EF-1-107-18  
Stethoscope  
18 cm,



Pinard  
EF-1-108-15  
Stethoscope  
15cm,

# Anesthesia



**Magill**  
EF-2-101-15  
Catheter Introducing Forceps  
14.5 cm, 20 cm, 25 cm,



**Miller**  
EF-2-102-00  
Laryngoscope Sets



**Miller-Baby**  
EF-2-103-00  
Laryngoscope Sets



**Miller**  
EF-2-104-00  
Laryngoscope Blade  
Fig. 0, Fig. 1, Fig. 2, Fig. 3, Fig. 4,



**Guedel-Negus**  
EF-2-105-00  
Laryngoscope Sets  
Fig. 2, Fig. 3, Fig. 4,



**Guedel-Negus**  
EF-2-106-00  
Laryngoscope Sets  
Fig. 1, Fig. 2, Fig. 3, Fig. 4,

# Anesthesia



Guedel-Negus  
EF-2-107-01  
Laryngoscope Blades  
Fig. 1, Fig. 2, Fig. 3, Fig. 4,



McIntosh  
EF-2-108-00



McIntosh  
EF-2-109-00  
Laryngoscope Blades  
Fig. 0, Fig. 1, Fig. 2, Fig. 3, Fig. 4,



McIntosh  
EF-2-110-00  
Laryngoscope Sets  
Fig. 1, Fig. 2, Fig. 3, Fig. 4,



Foregger  
EF-2-111-01  
Laryngoscope Blades  
Fig. 1, Fig. 2, Fig. 3, Fig. 4,



Battery Handle  
EF-2-112-00  
Battery Handle

# Anesthesia



McIntosh  
EF-2-114-00  
Laryngoscope Sets fiber optic  
Fig. 1, Fig. 2, Fig. 3,



McIntosh  
EF-2-115-00  
Laryngoscope Sets fiber optic  
Fig. 1, Fig. 2, Fig. 3,



McIntosh  
EF-2-116-00  
Laryngoscope Sets fiber optic  
Fig. 1, Fig. 2, Fig. 3,



McIntosh  
EF-2-113-00  
Laryngoscope Sets  
Fig. 1, Fig. 2, Fig. 3, Fig. 4,

# Trocars



Universal  
EF-3-101-04  
Trocar  
14 cm,



Nelson  
EF-3-102-07  
Trocar  
20 cm,



Lichtwitz  
EF-3-103-19  
Antrum Trocar  
18.5 cm,



Adson  
EF-3-104-21  
Suction Cannula  
20 cm,



Frazier  
EF-3-105-10  
Suction Cannula  
24 cm,



Frazier  
EF-3-106-06  
Suction Cannula  
19.5 cm,

# Trocars



Poppen  
EF-3-107-06  
Suction Cannula  
18 cm,



Luer  
EF-3-108-30  
Suction Tube working length 110 mm



Yasargil  
EF-3-109-15  
Suction Tube working length 150 mm with  
Luer hub  
21.5 cm,



Yankauer  
EF-3-110-27  
Suction Tube complete with suction tip and  
connector  
31 cm,



Yankauer  
EF-3-111-00  
Suction Tube  
31 cm, 15 cm, 2.5 cm, 10 cm,



Poole  
EF-3-112-22  
Suction Tube  
22 cm,



## Trocars



Poole  
EF-3-113-22  
Suction Tube  
22.5 cm,



Nuboer  
EF-3-114-21  
Suction Tube  
21 cm,



Nuboer  
EF-3-115-21  
Suction Tube  
21 cm,



Quinke  
EF-3-116-10  
Lumbar Puncture Needle



Tuohy  
EF-3-117-12  
Lumbar Puncture Needle Luer Lock  
connection with special tip



Verres  
EF-3-118-20  
Insufflation Cannula Luer Lock connection  
15 cm,

## Trocars



Verres

EF-3-119-20

Insufflation Cannula Luer Lock connection  
17 cm,

# Suture



**Kalt**  
EF-4-105-14  
Needle Holder  
13.5 cm,



**Barraquer-Troutman**  
EF-4-106-10  
Micro Needle Holder  
10 cm, 10.5 cm,



**Arruga**  
EF-4-107-14  
Micro Needle Holder  
13.5 cm,



**Barraquer-Troutman**  
EF-4-108-10  
Micro Needle Holder  
10.5 cm, 11.5 cm,



**Barraquer**  
EF-4-109-11  
Micro Needle Holder  
11.5 cm, 13.5 cm, 14 cm,



**Barraquer**  
EF-4-110-13  
Micro Needle Holder  
13.5 cm,

# Suture



Castroviejo-Fino  
EF-4-111-01  
Micro Needle Holder  
13 cm,



Castroviejo-Fino  
EF-4-112-01  
Micro Needle Holder  
13 cm,



Castroviejo-Fino  
EF-4-113-01  
very delicate jaw with lock  
13 cm,



Castroviejo  
EF-4-114-14  
Micro Needle Holder with lock  
14 cm,



Castroviejo  
EF-4-115-14  
Micro Needle Holder  
14 cm,



Castroviejo  
EF-4-121-14  
Micro Needle Holder with lock  
14 cm,

# Suture



Castroviejo  
EF-4-122-14  
Micro Needle Holder  
14 cm,



Castroviejo  
EF-4-124-13  
Micro Needle Holder with lock  
12 cm,



Arruga  
EF-4-123-16  
Needle Holder delicate  
16 cm,



Castroviejo  
EF-4-125-12  
Micro Needle Holder with lock  
12 cm,



Derf  
EF-4-126-12  
Needle Holder  
12 cm, 13 cm,

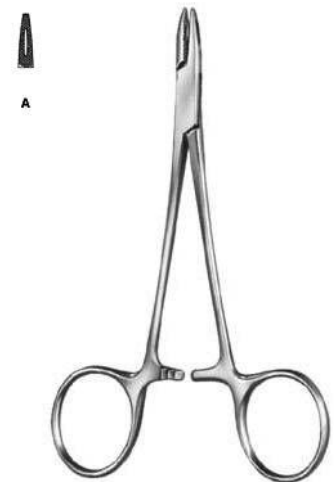

Collier  
EF-4-127-12  
Needle Holder  
12.5 cm,

# Suture

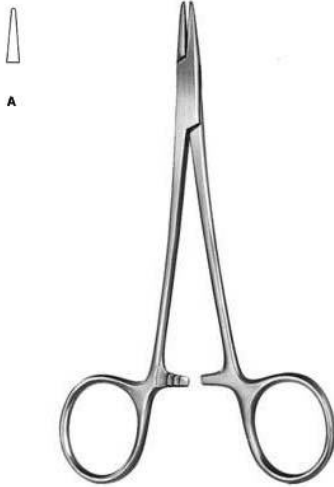

Webster  
EF-4-128-13  
Needle Holder  
13 cm,

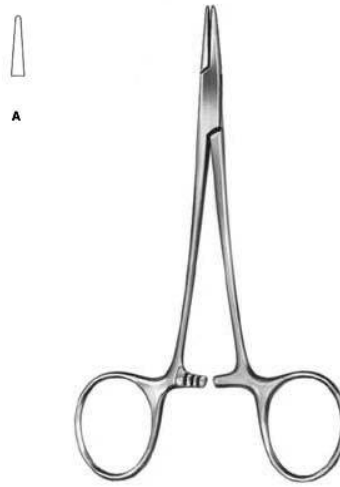

Halsey  
EF-4-129-13  
Needle Holder  
13.5 cm,



Neivert  
EF-4-130-13  
Needle Holder  
12.5 cm,



Hegar-Baumgartner  
EF-4-131-14  
Needle Holder  
14.5 cm,



Crile-Murray  
EF-4-133-15  
Needle Holder  
15 cm,



Crile-Wood  
EF-4-134-15  
Needle Holder  
15 cm,

# Suture



**Adson**  
EF-4-140-18  
Needle Holder one fenestrated jaw  
18 cm,



**Metzenbaum**  
EF-4-141-18  
Needle Holder one grooved and fenestrated  
jaw  
18.5 cm,



**M. G. Hospital**  
EF-4-142-17  
Needle Holder  
17.5 cm,

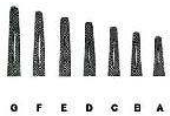

**Mayo-Hegar**  
EF-4-143-14  
Needle Holder  
14.5 cm, 16 cm, 18.5 cm, 20.5 cm, 24 cm, 26.5  
cm,



**Mayo-Hegar**  
EF-4-144-16  
Needle Holder  
16 cm, 18.5 cm, 20.5 cm,



**Brown**  
EF-4-145-13  
Needle Holder  
13 cm, 18 cm,

# Suture

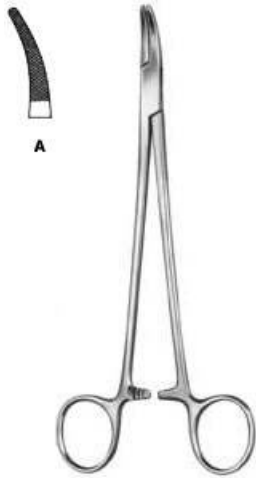

Heaney  
EF-4-146-21  
Needle Holder  
20.5 cm,

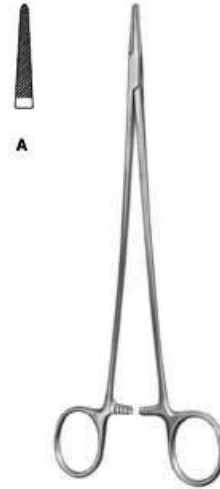

Jamison  
EF-4-147-23  
Needle Holder  
23.5 cm,



Masson  
EF-4-148-27  
Needle Holder  
26.5 cm,

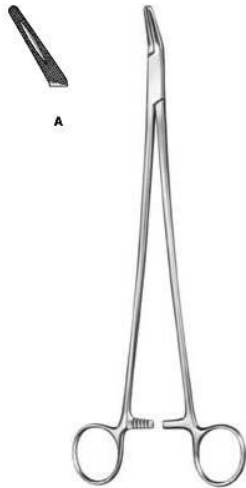

Finochietto  
EF-4-149-27  
Needle Holder  
26.5 cm,



Wangensteen  
EF-4-150-27  
Needle Holder  
26.5 cm,

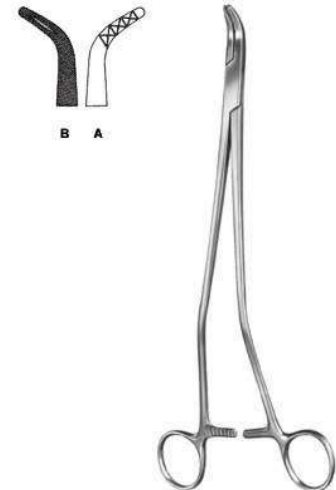

Johnson  
EF-4-151-27  
Needle Holder  
27 cm,



# Suture

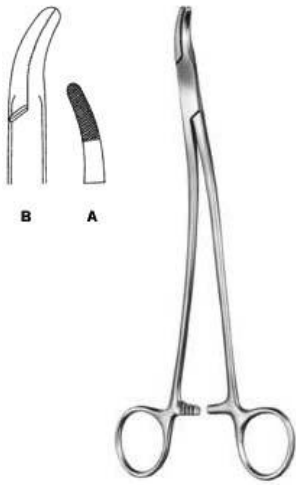

**Stratte**  
EF-4-152-23  
Needle Holder  
23 cm,

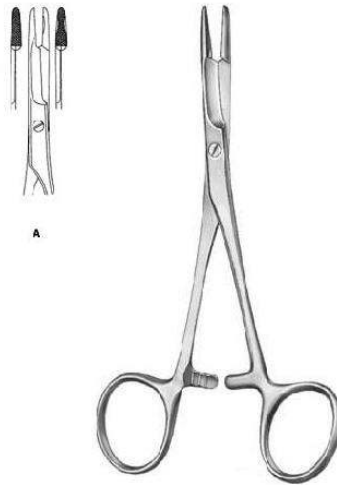

**Olsen-Hegar**  
EF-4-153-14  
Needle Holder  
14 cm,

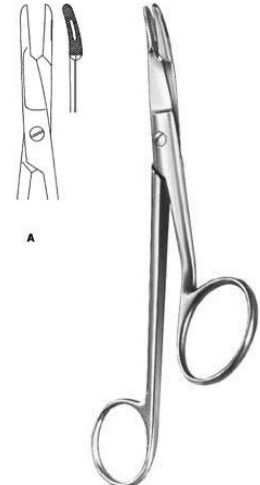

**Gillies**  
EF-4-154-16  
Needle Holder  
16 cm,



**Crile**  
EF-4-155-15  
Needle Holder  
15 cm,



**Mathieu**  
EF-4-156-14  
Needle Holder  
14 cm, 17 cm, 20 cm,



**Mathieu**  
EF-4-157-14  
Needle Holder  
14 cm, 16.5 cm,

# Suture



Toennis  
EF-4-158-18  
Needle Holder  
18.5 cm,



Lichtenberg  
EF-4-159-20  
Needle Holder  
20 cm,



EF-4-160-16  
Micro Needle Holder  
16 cm,



EF-4-161  
Micro Needle Holder  
23 cm, 19 cm,



Hepp-Scheidel  
EF-4-162-18  
Micro Needle Holder smooth jaw  
18 cm,

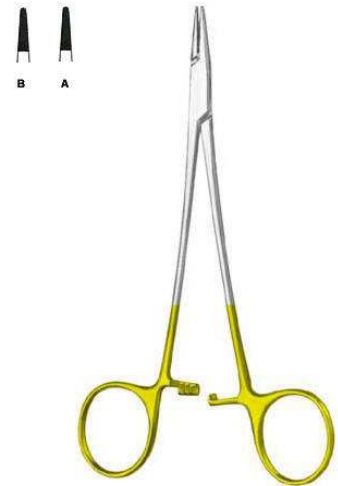

Webster  
EF-4-163-13  
Needle Holder with automatic release ratchet  
also for lefthanders  
13 cm, 15 cm,

# Suture



**EF-4-164-15**  
Micro Needle Holder  
15 cm, 18 cm, 21 cm, 23 cm,



**JABOMA**  
**EF-4-165-18**  
Micro Needle Holder  
18 cm,



**Castroviejo**  
**EF-4-166**  
Micro Needle Holder  
14.5 cm, 18 cm, 21.5 cm,



**Arruga**  
**EF-4-167**  
Needle Holder  
16 cm,



**Castroviejo**  
**EF-4-168-13**  
Micro Needle Holder  
12.5 cm,



**Barraquer**  
**EF-4-169-13**  
Micro Needle Holder  
13 cm,

# Suture



Barraquer  
EF-4-170-13  
Micro Needle Holder  
13 cm,



Webster  
EF-4-171-13  
Needle Holder  
13 cm,



Derf  
EF-4-173-12  
Needle Holder  
12 cm,

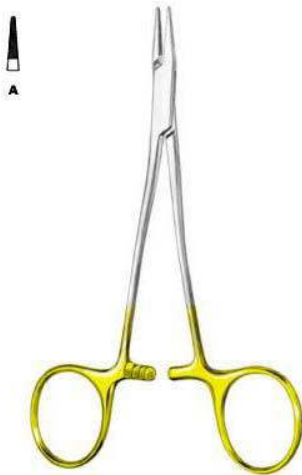

Kilner  
EF-4-172-13  
Needle Holder  
13 cm,



Hegar-Baumgartner  
EF-4-174-13  
Needle Holder  
13 cm, 14.5 cm,



Halsey  
EF-4-175-12  
Needle Holder  
13 cm, 12 cm,

# Suture



**Crile-Wood**  
EF-4-176-15  
Needle Holder  
15 cm,



**Sarot**  
EF-4-177-18  
Needle Holder  
18 cm,20 cm,26 cm,

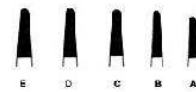

**Mayo-Hegar**  
EF-4-178-16  
Needle Holder standard profile  
16 cm,18 cm,20 cm,24 cm,26 cm,30 cm,



**Heaney**  
EF-4-179-20  
Needle Holder  
20 cm,24 cm,26 cm,

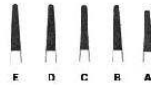

**DeBakey**  
EF-4-180-18  
Needle Holder delicate pattern mini profile  
18 cm,20 cm,23 cm,26 cm,31 cm,



**Masson**  
EF-4-181-27  
Needle Holder  
26.5 cm,

# Suture



Barraquer  
EF-4-170-13  
Micro Needle Holder  
13 cm,



Webster  
EF-4-171-13  
Needle Holder  
13 cm,



Derf  
EF-4-173-12  
Needle Holder  
12 cm,

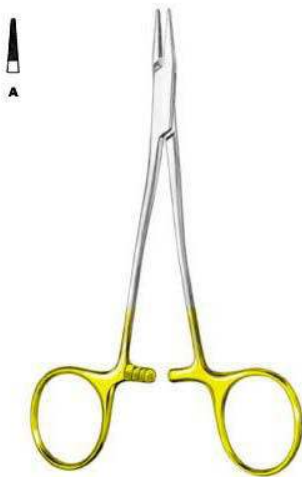

Kilner  
EF-4-172-13  
Needle Holder  
13 cm,



Hegar-Baumgartner  
EF-4-174-13  
Needle Holder  
13 cm, 14.5 cm,



Halsey  
EF-4-175-12  
Needle Holder  
13 cm, 12 cm,

# Suture

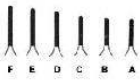

**Ryder (Martin)**  
EF-4-182-13

Needle Holder  
12.5 cm, 15 cm, 18 cm, 20 cm, 23 cm, 26 cm,

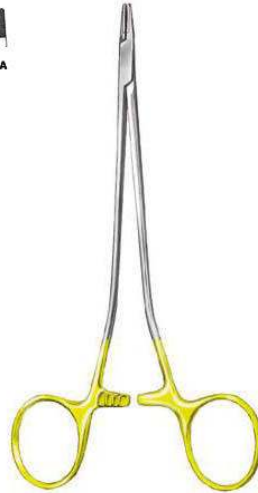

**Martin**

EF-4-183-15

Needle Holder mini profile elastic type  
15 cm, 17 cm, 20 cm,



**Wangensteen**

EF-4-184-27

Needle Holder standard profile  
27 cm,



**Hegar-Vascular**

EF-4-185-14

Needle Holder micro profile  
14 cm, 18.5 cm, 20.5 cm, 23 cm,

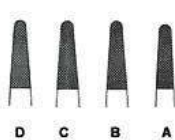

**Bozemann**

EF-4-186-20

Needle Holder standard profile  
20.5 cm, 24 cm, 26.5 cm, 29 cm,



**Hegar**

EF-4-187-20

Needle Holder standard profile  
20 cm, 23.5 cm,

# Suture



**Lichtenberg**  
EF-4-194-20  
Needle Holder lightweight model standard profile  
20 cm,



**Langenbeck**  
EF-4-195-18  
Needle Holder  
18 cm, 20.5 cm, 23 cm,



**Zweifel**  
EF-4-196-20  
Needle Holder with hinged ratchet standard profile  
20.5 cm, 23 cm,



**Reverdin**  
EF-4-197-15  
Reverdin Needle short  
14.5 cm Fig. 1, 14.5 cm Fig. 2, 14.5 cm Fig. 3, 14.5 cm Fig. 4,

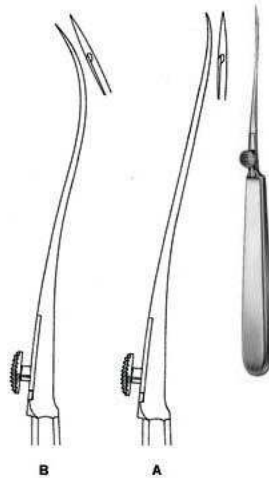

**Reverdin**  
EF-4-198-19  
Reverdin Needle medium  
19.5 cm Fig. 1, 19.5 cm Fig. 2, 19.5 cm Fig. 3, 19.5 cm Fig. 4,

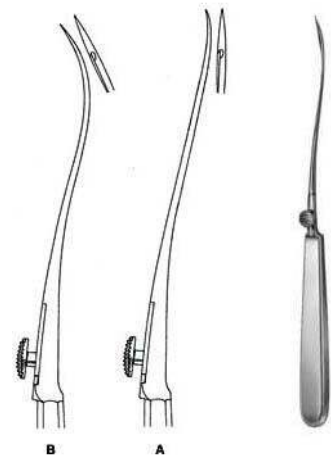

**Reverdin**  
EF-4-199-23  
Reverdin Needle long  
23 cm Fig. 1, 23 cm Fig. 2, 23 cm Fig. 3, 23 cm Fig. 4,



# Suture

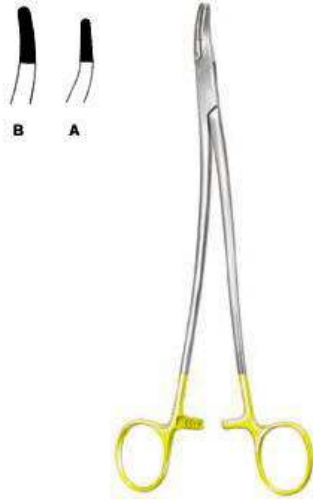

**Stratte**  
EF-4-188-22  
Needle Holder standard profile  
23 cm,



**Microvascular**  
EF-4-189-00  
Needle Holder slender pattern micro profile  
14 cm, 17.5 cm, 20 cm, 23 cm,



**Mathieu**  
EF-4-190-14  
Needle Holder  
14 cm, 17 cm, 20 cm,



**Mathieu**  
EF-4-191-14  
Needle Holder  
14 cm, 17 cm, 20 cm,



**Mathieu**  
EF-4-192-17  
Needle Holder standard profile with interior  
ratchet  
17 cm, 20 cm, 23 cm,



**Toennis**  
EF-4-193-18  
Needle Holder  
18.5 cm,

# Suture

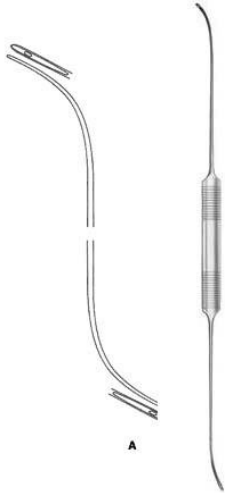

Schmieden-Dick  
EF-4-201-01  
Ligature Needle malleable  
29 cm,

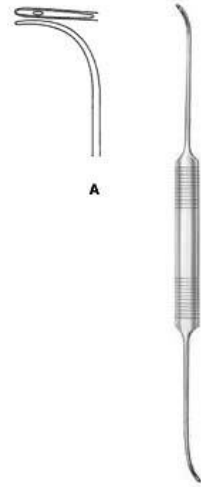

Schmieden  
EF-4-202-21  
Ligature Needle  
24 cm,



EF-4-203-20  
Ligature Needle malleable  
20.5 cm,

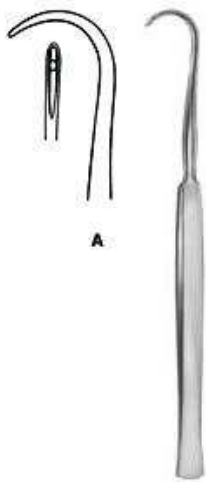

Cooper  
EF-4-204-19  
Ligature Needle  
18.5 cm,



Kronecker  
EF-4-205-13  
Ligature Needle delicate for right hand  
12.5 cm,

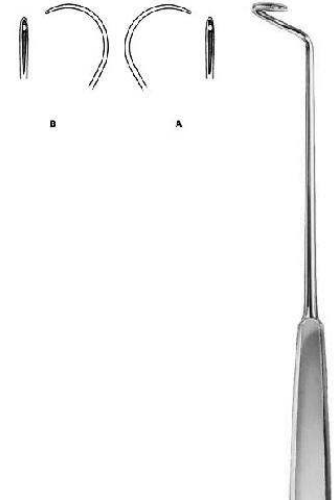

Deschamps  
EF-4-206-24  
Ligature Needle blunt for right hand  
24 cm,

# Suture



Deschamps  
EF-4-207-20  
Ligature Needle blunt for right hand  
20 cm,



Deschamps  
EF-4-208-20  
Ligature Needle sharp for right hand  
20 cm,

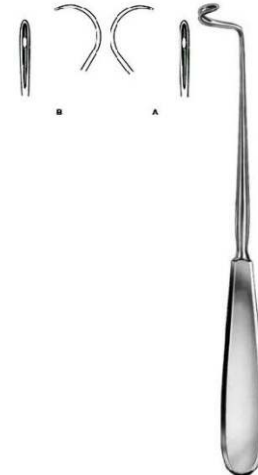

Deschamps  
EF-4-209-21  
Ligature Needle blunt for right hand  
20 cm,

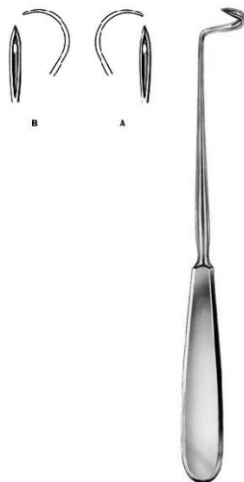

Deschamps  
EF-4-210-21  
Ligature Needle sharp for right hand  
20 cm,

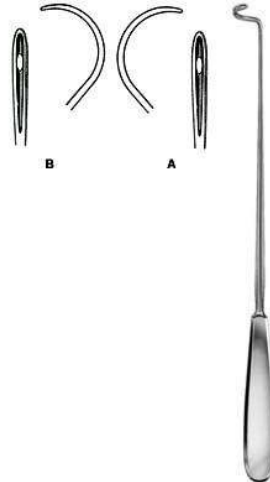

Deschamps  
EF-4-211-27  
Ligature Needle blunt for right hand  
27 cm,

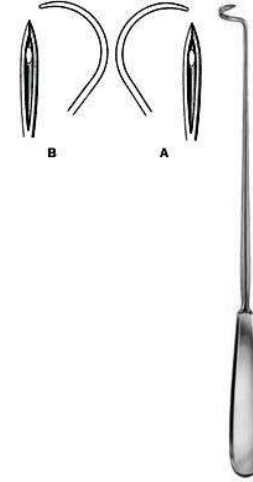

Deschamps  
EF-4-212-27  
Ligature Needle sharp for right hand  
27 cm,

# Suture

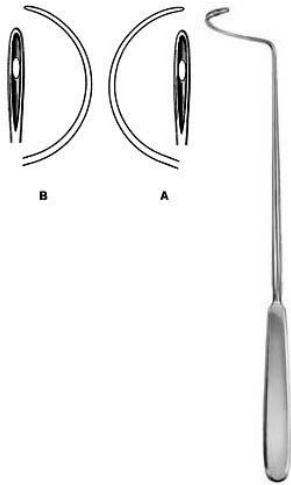

Deschamps  
EF-4-213-28  
Ligature Needle blunt for right hand  
28 cm,

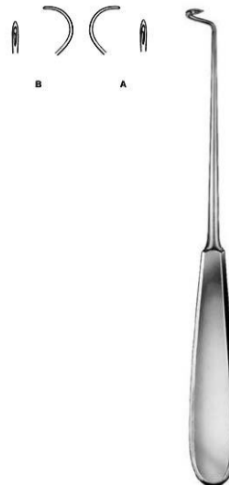

Deschamps  
EF-4-214-20  
Ligature Needle sharp for right hand  
20 cm,



Deschamps  
EF-4-215-20  
Ligature Needle blunt for right hand  
20 cm,



Deschamps  
EF-4-216-20  
Ligature Needle blunt for right hand  
21 cm,

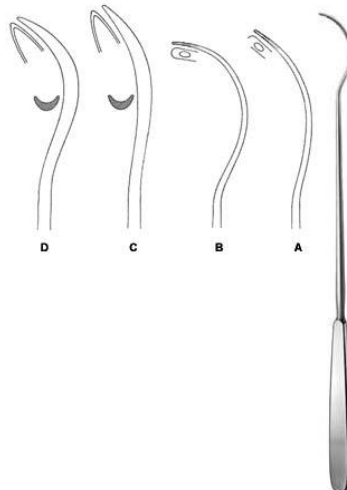

Brunner  
EF-4-217-30  
Ligature Needle  
21 cm,



Kirschner  
EF-4-218-25  
Ligature Conductor  
25.5 cm,

## Suture

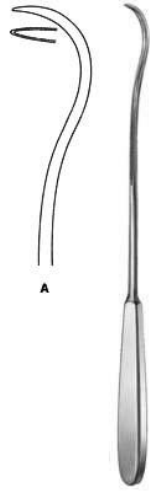

EF-4-219-28  
Ligature Conductor  
28 cm,



Modell Wien  
EF-4-220-23  
Ligature Catcher  
23.5 cm,



Michel  
EF-4-221-12  
Clip Applying Forceps  
12 cm,



Hegenbarth  
EF-4-222-12  
Clip Applying Forceps  
12 cm,

# Scalpels



EF-5-101-01  
Dissecting Knife with metal handle  
15 cm, 15.5 cm, 16 cm, 17 cm,



EF-5-102-10  
Autopsy Knife  
25.5 cm,

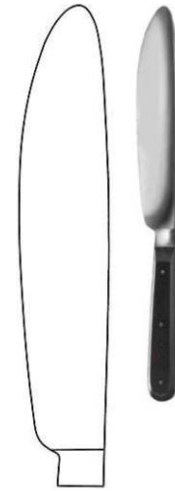

Walb  
EF-5-104-17  
Post Mortem Knife

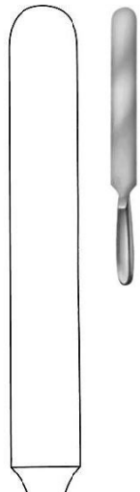

Virchow  
EF-5-105-20  
Brain Knife with hollow handle  
28.5 cm, 33.5 cm, 38 cm,



EF-5-108-04  
Scalpel Handle solid  
13.5 cm,



EF-5-109-34  
Scalpel Handle  
16 cm,

# Scalpels



EF-5-110-41  
Scalpel Handle solid, long  
21 cm,



EF-5-111-45  
Scalpel Handle  
21 cm,



Collin  
EF-5-112-08  
Scalpel Handle with hollow handle  
13.5 cm,



Collin  
EF-5-113-09  
Scalpel Handle with hollow handle  
14.5 cm,



EF-5-114-03  
Scalpel Handle solid  
12 cm,



EF-5-115-04  
Scalpel Handle  
12 cm,

# Scalpels



EF-5-116-05  
Scalpel Handle  
12 cm,



EF-5-117-31  
Scalpel Handle solid, long  
21.5 cm,



EF-5-118-35  
Scalpel Handle  
21 cm,



EF-5-119-07  
Scalpel Handle solid  
16 cm,



EF-5-120-71  
Scalpel Handle solid short  
12.5 cm,



EF-5-121-03  
Scalpel Handle with round hollow handle  
15.5 cm,



## Scalpels



EF-5-127-16  
Amputation Knife with hollow handle  
29 cm,



EF-5-128-19  
Amputation Knife with hollow handle  
32.5 cm,



Catlin  
EF-5-129-16  
Interosseous Knife with hollow handle  
29cm,



EF-5-130-06  
Resection Knife solid handle, dissecting end  
18 cm,



Langenbeck  
EF-5-131-05  
Resection Knife  
18 cm,



Langenbeck  
EF-5-132-05  
Resection Knife  
18 cm,

## Scalpels



EF-5-133-00

Razor Knife hollow blades on both sides  
cutting length 75mm



Schink

EF-5-134-00

Dermatome complete with 2 skin fixing plates  
and one blade  
31 cm,



Schink

EF-5-135-01

Spare Blade spare blade for KE-05-134-00



Schink

EF-5-136-02

Skin Fixing Plate for KE-05-134-00

# Scissors



Standard BL / BL Straight  
EF-5-201-13

Operating Scissor Special  
12 cm, 13 cm, 14.5 cm, 16.5 cm, 18.5 cm, 20.5 cm,



Standard SH / BL STR  
EF-5-202-13

Operating Scissors  
12 cm, 13 cm, 14.5 cm, 16.5 cm, 18.5 cm, 20.5 cm,



Standard SH / SH STR  
EF-5-204-13

Operating Scissors  
12 cm, 13 cm, 14.5 cm, 16.5 cm,



Standard BL / BL Curved  
EF-5-205-13

Operating Scissors  
12 cm, 13 cm, 14.5 cm, 16.5 cm, 18.5 cm, 20.5 cm,

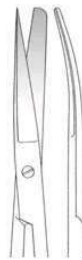

Standard SH / BL Curved  
EF-5-206-13

Operating Scissors  
12 cm, 13 cm, 14.5 cm, 16.5 cm, 18.5 cm, 20.5 cm,



Standard SH / SH Curved  
EF-5-207-13

Operating Scissors  
12 cm, 13 cm, 14.5 cm, 16.5 cm,

# Scissors



Standard BL / BL Curved  
EF-5-208-14  
Operating Scissors delicate  
14.5 cm,



Incision Scissor  
EF-5-209-14  
Operating Scissor  
14.5 cm,



Deaver  
EF-5-210-14  
Operating Scissors



Mayo  
EF-5-211-15  
Dissecting Scissors  
14.5 cm, 15 cm, 17 cm, 23.5 cm, 14.5 cm, 15 cm, 17 cm, 23.5 cm,



Mayo  
EF-5-212-23  
Dissecting Scissors  
23 cm, 22.5 cm, 28 cm,



Mayo-Harrington  
EF-5-213-22  
Dissecting Scissors  
23 cm, 22.5 cm, 28 cm,

# Scissors

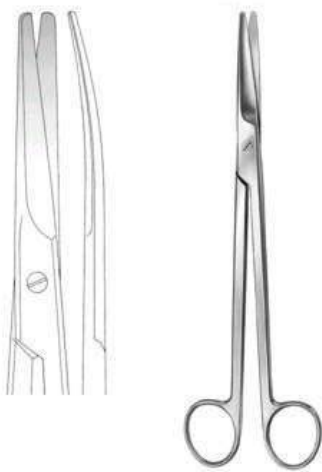

**Mayo-Harrington**  
**EF-5-214-22**  
 Dissecting Scissors cur.  
 22.5 cm, 28 cm, 23 cm,

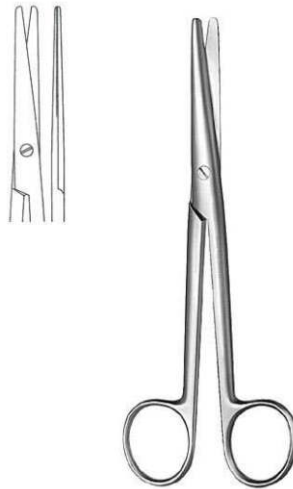

**Mayo-Stille**  
**EF-5-215-17**  
 Dissecting Scissors str.  
 15 cm, 17 cm,

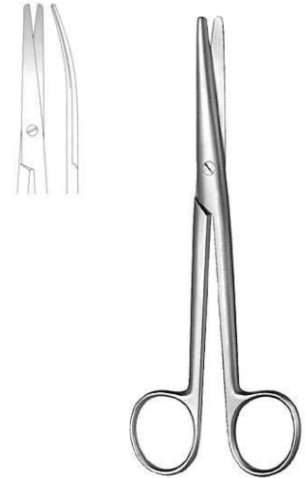

**Mayo-Stille**  
**EF-5-216-15**  
 Dissecting Scissors cur.  
 15 cm, 17 cm,

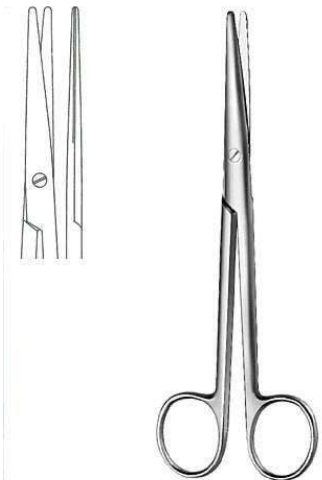

**Mayo-Stille**  
**EF-5-217-19**  
 Dissecting Scissors str.  
 16 cm, 19.5 cm, 21.5 cm,

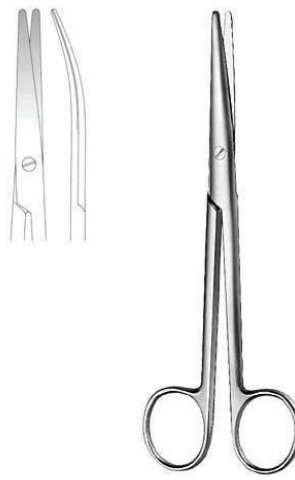

**Mayo-Stille**  
**EF-5-218-16**  
 Dissecting Scissors cur.  
 16 cm, 19.5 cm, 21.5 cm,



**Mayo-Noble**  
**EF-5-219-17**  
 Gynecological Scissors  
 16.5 cm,

## Scissors



Sims  
EF-5-220-23  
Gynecological Scissors str.  
20 cm, 23 cm,



Sims  
EF-5-221-20  
Gynecological Scissors cur.  
20 cm, 23 cm,



Kelly  
EF-5-222-16  
Operating Scissors  
16 cm,



Doyen  
EF-5-223-17  
Gynecological Scissors  
18.5 cm,



Sims-Siebold  
EF-5-224-24  
Gynecological Scissors  
24.5 cm,



Sims-Siebold  
EF-5-225-24  
Gynecological Scissors  
24.5 cm,

# Scissors



Wertheim  
EF-5-226-23  
Gynecological Scissors  
20 cm, 23 cm,



Metzenbaum  
EF-5-227-11  
Dissecting Scissors  
11.5 cm,



Metzenbaum  
EF-5-228-14  
Dissecting Scissors  
14.5 cm,



Metzenbaum  
EF-5-229-15  
Dissecting Scissors  
15.5 cm,



Metzenbaum-Nelson  
EF-5-230-20  
Dissecting Scissors  
18 cm, 20.5 cm, 23 cm, 26 cm, 28.5 cm, 31 cm,



Metzenbaum-Nelson  
EF-5-231-20  
Dissecting Scissors  
18 cm, 20.5 cm,

# Scissors



**Lexer**  
EF-5-238-16  
Dissecting Scissors  
16 cm,



**Cinelli**  
EF-5-239-14  
Nasal Scissors  
11.5 cm, 14 cm,



**Thorek**  
EF-5-240-19  
Dissecting Scissors  
18.5 cm,



**Lexer-Baby**  
EF-5-241-10  
Dissecting Scissors  
10 cm,



**Lexer-Fino**  
EF-5-242-16  
Delicate Dissecting Scissors slender pattern  
16.5 cm,



**Metzenbaum-Fino**  
EF-5-243-14  
Delicate Dissecting Scissors slender pattern  
14.5 cm,





# Scissors



**Metzenbaum-Nelson**  
EF-5-232-20  
Dissecting Scissors  
18 cm, 20.5 cm, 23 cm, 26 cm, 28.5 cm, 31 cm,



**Metzenbaum**  
EF-5-233-14  
Dissecting Scissors toothed  
14.5 cm,



**Nerve Operating Scissor**  
EF-5-234-15  
Dissecting Scissors  
15.5 cm,



**Gorney**  
EF-5-235-19  
Face-lift Scissors str.  
12.5 cm, 19.5 cm,



**Gorney**  
EF-5-236-19  
Face-lift Scissors cur.  
19.5 cm,



**Aston**  
EF-5-237-17  
Face-lift Scissors  
17 cm,

# Scissors



Metzenbaum-Fino  
EF-5-244-14  
Delicate Dissecting Scissors  
14.5 cm,



Metzenbaum-Fino  
EF-5-245-14  
Delicate Dissecting Scissors  
14.5 cm,



Metzenbaum-Fino  
EF-5-246-14  
Delicate Dissecting Scissors  
14.5 cm,

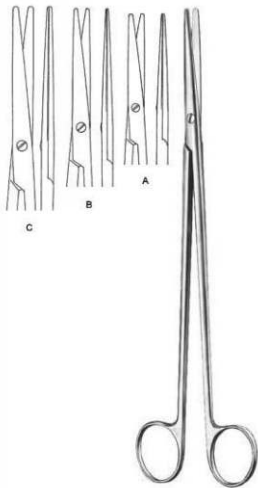

Metzenbaum-Fino  
EF-5-247-18  
Delicate Dissecting Scissors slender pattern  
18 cm,20 cm,23 cm,

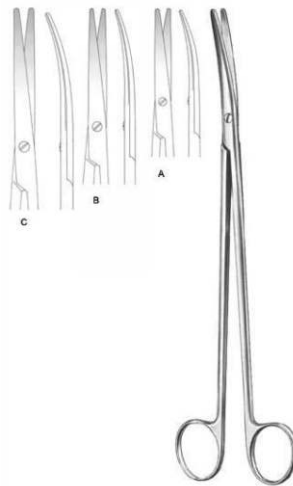

Metzenbaum-Fino  
EF-5-248-18  
Delicate Dissecting Scissors slender pattern  
18 cm,20 cm,23 cm,

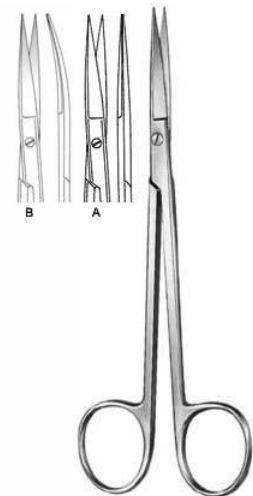

Sanvenero  
EF-5-250-14  
Operating Scissors  
14 cm,

# Scissors

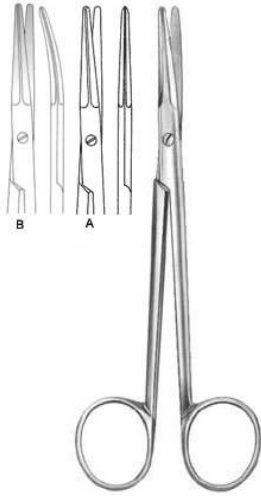

EF-5-257-14  
Dissecting Scissors  
14.5 cm,

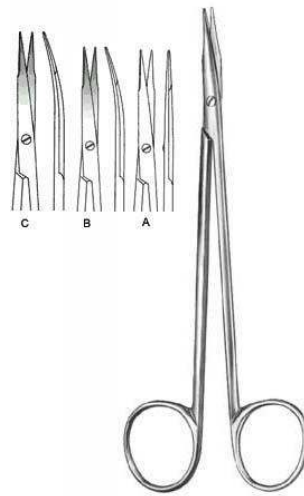

Reynolds  
EF-5-258-15  
Dissecting Scissors  
15.5 cm, 18 cm,



Jameson  
EF-5-259-14  
Dissecting Scissors  
15.5 cm,



Jameson  
EF-5-260-14  
Dissecting Scissors  
15.5 cm,



EF-5-261-19  
Vascular Scissors  
19 cm,

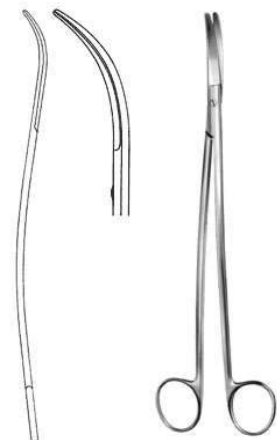

EF-5-262-24  
Vascular Scissors fine, short blades  
19 cm, 25.5 cm,

# Scissors

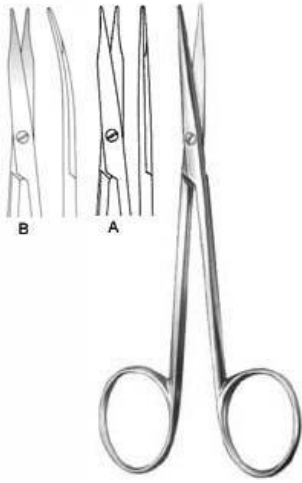

**EF-5-251-11**  
**Fine Operating Scissors**  
 11.5 cm,

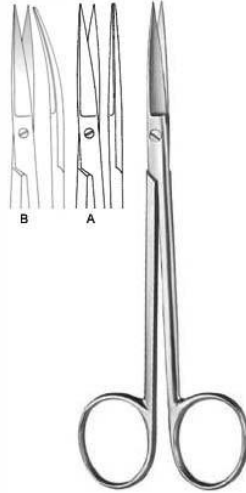

**Joseph**  
**EF-5-252-14**  
**Operating Scissors**  
 14.5 cm,

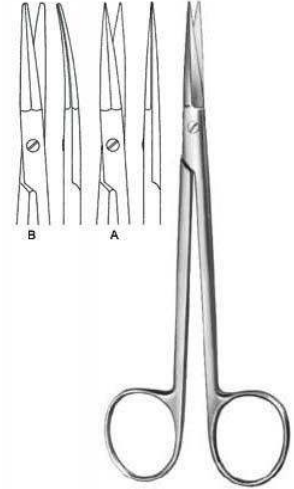

**Peck-Joseph**  
**EF-5-253-14**  
**Face-lift Scissors**  
 14.5 cm,

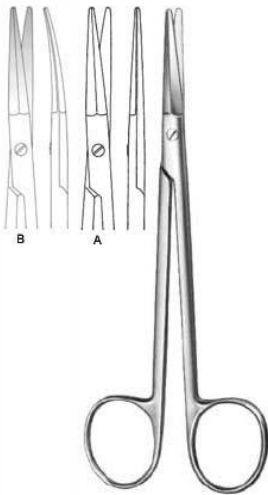

**Peck-Joseph**  
**EF-5-254-14**  
**Face-lift Scissors**  
 14.5 cm,



**Shea Vein Graft**  
**EF-5-255-12**  
**Dissecting Scissors**  
 12 cm,

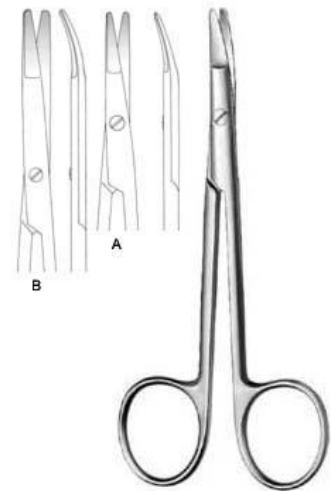

**Kilner**  
**EF-5-256-12**  
**Dissecting Scissors**  
 12 cm, 15 cm,

# Scissors

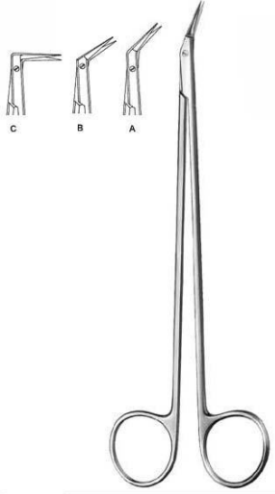

**Diethrich**  
**EF-5-263-25**  
 Vascular Scissors  
 19 cm, 18.5 cm, 17.5 cm,

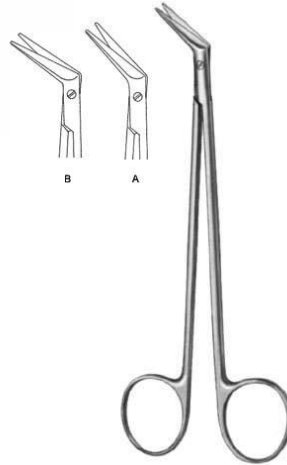

**DeBakey**  
**EF-5-264-45**  
 Vascular Scissors  
 16.5 cm, 16 cm,

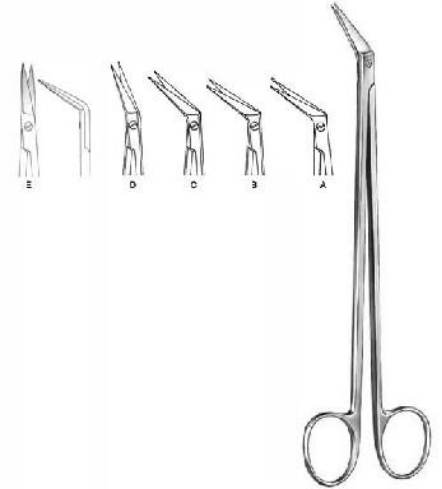

**Potts-Smith**  
**EF-5-265-19**  
 Vascular Scissors  
 18 cm, 18.5 cm, 19 cm,



**Coronary Scissors**  
**EF-5-266-25**  
 Cardiovascular Surgery Scissor  
 18 cm,



**Coronary Scissors**  
**EF-5-267-45**  
 Cardiovascular Surgery Scissors  
 18 cm,



**Coronary Scissors**  
**EF-5-268-60**  
 Cardiovascular Surgery Scissor  
 18 cm,

# Scissors

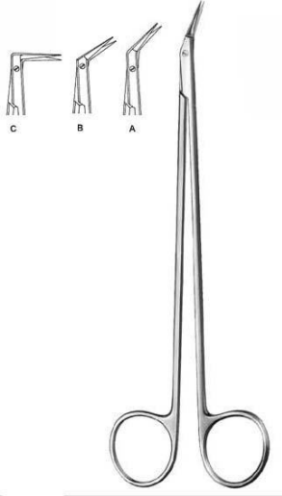

**Diethrich**  
**EF-5-263-25**  
 Vascular Scissors  
 19 cm, 18.5 cm, 17.5 cm,

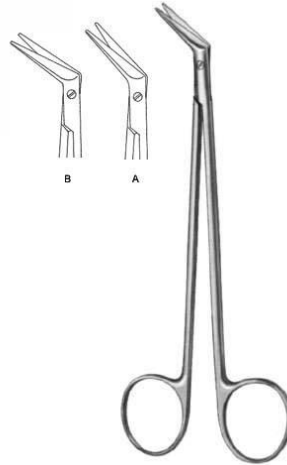

**DeBakey**  
**EF-5-264-45**  
 Vascular Scissors  
 16.5 cm, 16 cm,

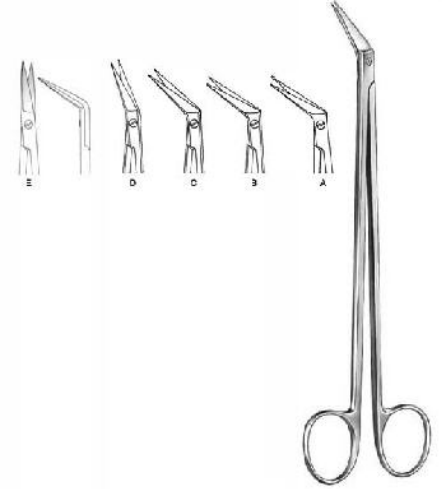

**Potts-Smith**  
**EF-5-265-19**  
 Vascular Scissors  
 18 cm, 18.5 cm, 19 cm,



**Coronary Scissors**  
**EF-5-266-25**  
 Cardiovascular Surgery Scissor  
 18 cm,



**Coronary Scissors**  
**EF-5-267-45**  
 Cardiovascular Surgery Scissors  
 18 cm,



**Coronary Scissors**  
**EF-5-268-60**  
 Cardiovascular Surgery Scissor  
 18 cm,

# Scissors



Coronary Scissors  
EF-5-269-90  
Cardiovascular Surgery Scissor  
18 cm,



Coronary Scissors  
EF-5-270-00  
Cardiovascular Surgery Scissor  
18 cm,



Coronary Scissors  
EF-5-271-00  
Cardiovascular Surgery Scissor  
18 cm,



Coronary Scissors  
EF-5-272-25  
Cardiovascular Surgery Scissor  
18 cm,



Coronary Scissors  
EF-5-273-45  
Cardiovascular Surgery Scissor  
18 cm,



Coronary Scissors  
EF-5-274-90  
Cardiovascular Surgery Scissor  
18 cm,

# Scissors



Coronary Scissors  
EF-5-269-90  
Cardiovascular Surgery Scissor  
18 cm,



Coronary Scissors  
EF-5-270-00  
Cardiovascular Surgery Scissor  
18 cm,



Coronary Scissors  
EF-5-271-00  
Cardiovascular Surgery Scissor  
18 cm,



Coronary Scissors  
EF-5-272-25  
Cardiovascular Surgery Scissor  
18 cm,



Coronary Scissors  
EF-5-273-45  
Cardiovascular Surgery Scissor  
18 cm,



Coronary Scissors  
EF-5-274-90  
Cardiovascular Surgery Scissor  
18 cm,



## Scissors



Schmieden-Taylor  
EF-5-275-17  
Dura Scissors  
15 cm,



Strully  
EF-5-276-22  
Neurosurgical Scissors  
22.5 cm,



Toennis-Adson  
EF-5-277-17  
Dissecting Scissors  
17.5 cm,



Good  
EF-5-279-19  
Tonsil Scissors  
19.5 cm,



Fomon  
EF-5-282-15  
Nasal Scissors  
15 cm,



Cottle  
EF-5-283-16  
Nasal Scissors  
16 cm,

# Scissors



Heymann  
EF-5-284-18  
Nasal Scissors  
18.5 cm,



Heymann  
EF-5-285-18  
Nasal Scissors  
18.5 cm,



Converse  
EF-5-286-11  
Nasal Scissors blunt & sharp  
10.5 cm,



Waldmann  
EF-5-287-18  
Episiotomy Scissors  
18 cm,



Braun-Stadler  
EF-5-288-14  
Episiotomy Scissors  
14.5 cm,



Braun-Stadler  
EF-5-289-22  
Episiotomy Scissors  
22 cm,

# Scissors



Modell USA  
EF-5-290-10  
Umbilical Scissors  
10.5 cm,



Busch  
EF-5-292-16  
Umbilical Scissors  
16 cm,



Goldmann-Fox  
EF-5-293-13  
Gum Scissors  
13 cm,



Wagner  
EF-5-294-12  
Operating Scissors  
12 cm,

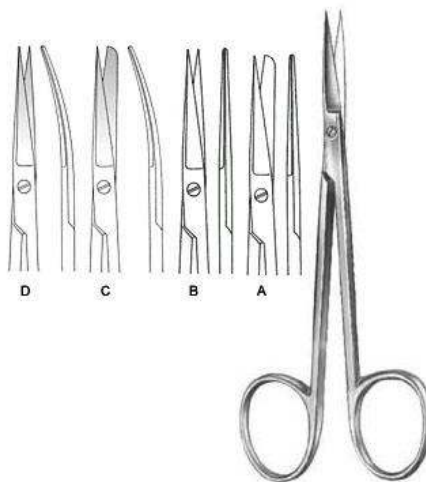

EF-5-295-12  
Operating Scissors small model  
12 cm,



La Grange  
EF-5-296-11  
Gum Scissors S-shaped  
11.5 cm,

# Scissors



EF-5-297-11  
Dissecting Scissors delicate  
11.5 cm,



Locklin  
EF-5-298-16  
Gum Scissors  
16 cm,



Locklin  
EF-5-299-16  
Gum Scissors  
16 cm,



EF-5-300-08  
Operating Scissors very delicate  
9 cm,

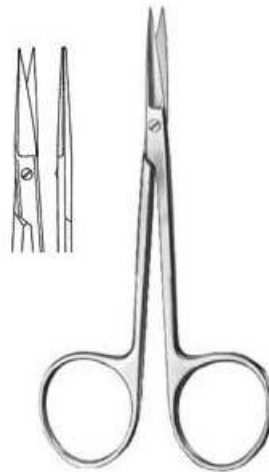

EF-5-301-10  
Iris Scissors  
9 cm, 10 cm,

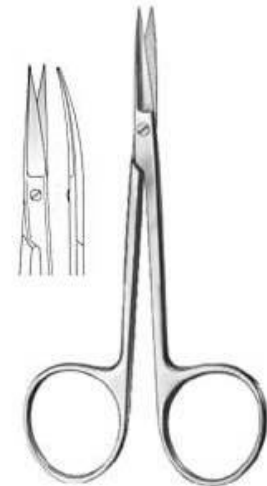

EF-5-302-10  
Iris Scissors extra flat blades  
10 cm,

## Dressing & Tissue Forceps



Standard

EF-5-401-10

Dressing Forceps

10.5 cm, 11.5 cm, 13 cm, 14.5 cm, 16 cm, 18 cm, 20 cm, 23 cm, 25 cm, 30.5 cm,



Standard

EF-5-402-11

Dressing Forceps

12 cm, 13 cm, 14.5 cm, 16 cm, 18 cm, 20 cm, 25 cm, 30 cm,



EF-5-403-13

Dressing Forceps

13 cm, 14.5 cm,



Stille

EF-5-404-15

Dressing Forceps

15 cm,



Mini-Adson

EF-5-405-12

Dressing Forceps

12 cm,



Adson

EF-5-406-12

Dressing Forceps

12 cm, 15 cm,

## Dressing & Tissue Forceps



McIndoe  
EF-5-407-15  
Dressing Forceps  
15 cm,



Waugh  
EF-5-408-20  
Dressing Forceps  
20 cm,



Semken  
EF-5-409-12  
Dressing Forceps  
12.5 cm, 15 cm,



Taylor  
EF-5-410-17  
Dressing Forceps  
12.5 cm, 15 cm,



Taylor  
EF-5-411-17  
Dressing Forceps  
17 cm,



Taylor  
EF-5-412-17  
Dressing Forceps  
18.5 cm,

## Dressing & Tissue Forceps



EF-5-413-06  
Micro Dressing Forceps  
15.5 cm,



Gerald  
EF-5-414-18  
Dressing Forceps  
15.5 cm,



Cushing  
EF-5-415-17  
Dressing Forceps  
17.5 cm,



Potts-Smith  
EF-5-416-18  
Dressing Forceps  
18 cm, 21 cm, 24.5 cm,



Bonney  
EF-5-417-17  
Dissecting Forceps  
17.5 cm,



Gerald  
EF-5-418-17  
Dissecting Forceps  
17.5 cm,

## Dressing & Tissue Forceps



Gillies  
EF-5-419-15  
Dissecting Forceps  
15.5 cm,



McIndoe  
EF-5-420-15  
Dressing Forceps  
15 cm,



Semken  
EF-5-421-16  
Dissecting Forceps  
15.5 cm, 17.5 cm,



Adson-Brown  
EF-5-422-12  
Dissecting Forceps  
12 cm,



Adson  
EF-5-423-12  
Dissecting Forceps  
12 cm, 15 cm,



Adson  
EF-5-424-12  
Dressing Forceps  
12 cm, 15 cm,



# Scissors



EF-5-303-10  
Iris Scissors extra flat blades  
10 cm,



Bonn  
EF-5-304-09  
Iris Scissors



Dean  
EF-5-278-17  
Tonsil Scissors  
17.5 cm,



Spencer Scissor  
EF-5-278-18

# Dressing & Tissue Forceps



Cushing  
EF-5-425-17  
Dressing Forceps  
17.5 cm,



Cushing  
EF-5-426-18  
Dressing Forceps  
17 cm,



Cushing-Taylor  
EF-5-427-18  
Dressing Forceps  
18.5 cm,



Potts-Smith  
EF-5-428-15  
Dressing Forceps  
16 cm, 18.5 cm, 20 cm, 23 cm, 25 cm,



Oehler  
EF-5-429-14  
Dissecting Forceps  
14.5 cm, 16 cm, 18 cm, 20 cm, 25 cm,



Wangensteen  
EF-5-430-15  
Dressing Forceps  
15 cm, 23 cm,

# Dressing & Tissue Forceps

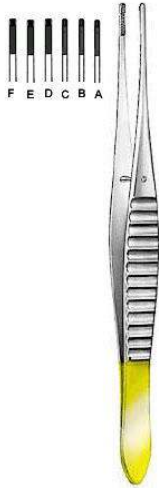

**DeBakey**  
EF-5-431-15

Atraumatic Dressing Forceps  
16 cm, 20 cm, 24.5 cm, 16 cm, 20 cm, 24.5 cm,



**DeBakey**  
EF-5-432-16

Atraumatic Dressing Forceps  
16 cm, 20 cm, 24 cm,

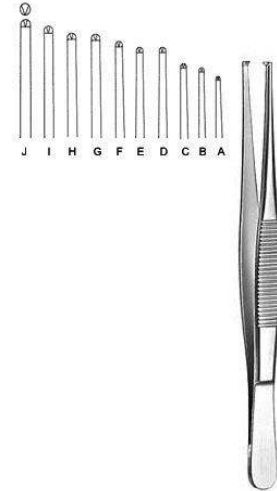

EF-5-433-10

Dissecting Forceps  
10.5 cm, 11.5 cm, 13 cm, 14.5 cm, 16 cm, 18 cm, 20 cm, 23 cm, 25 cm, 30.5 cm,

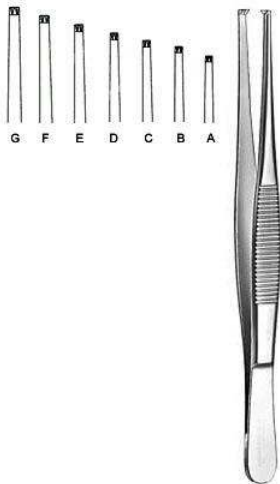

EF-5-434-11

Dissecting Forceps  
12 cm, 13 cm, 14.5 cm, 15.5 cm, 18 cm, 20 cm, 24.5 cm,



EF-5-435-14

Dissecting Forceps  
14.5 cm, 16 cm,



EF-5-436-14

Dissecting Forceps  
14.5 cm, 16 cm,

# Dressing & Tissue Forceps



EF-5-437-13  
Dissecting Forceps  
13 cm, 14.5 cm, 16 cm, 20 cm,



EF-5-438-13  
Dissecting Forceps  
13 cm, 14.5 cm,



Stille  
EF-5-439-15  
Dissecting Forceps  
15 cm,



Stille  
EF-5-440-15  
Dissecting Forceps  
15 cm,



Stone  
EF-5-441-15  
Dissecting Forceps  
15 cm,



Lerche  
EF-5-442-15  
Dissecting Forceps  
15 cm,

# Dressing & Tissue Forceps

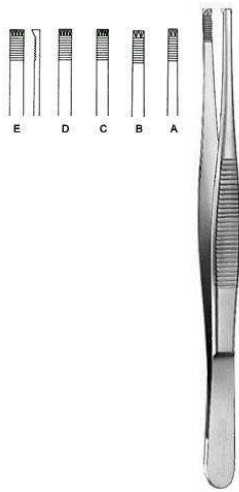

**Adlerkreutz**  
**EF-5-443-15**  
 Dissecting Forceps  
 15.5 cm, 20.5 cm, 16 cm, 20 cm, 25 cm,

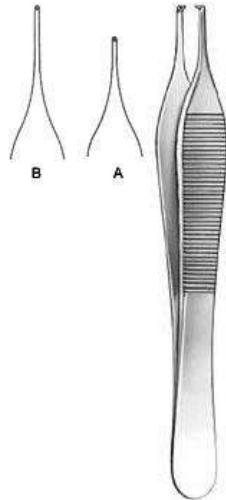

**Adson**  
**EF-5-444-12**  
 Dissecting Forceps  
 12 cm, 15 cm,



**Gillies**  
**EF-5-445-15**  
 Dissecting Forceps  
 15.5 cm,



**Waugh**  
**EF-5-446-20**  
 Dissecting Forceps  
 20.5 cm,



**Semken**  
**EF-5-447-12**  
 Dissecting Forceps  
 12.5 cm, 15 cm,



**Taylor**  
**EF-5-448-17**  
 Dissecting Forceps  
 17.5 cm,

## Dressing & Tissue Forceps



Taylor  
EF-5-449-17  
Dissecting Forceps  
17 cm,



Taylor  
EF-5-450-17  
Dissecting Forceps  
18.5 cm,



EF-5-451-06  
Micro Dissecting Forceps  
15.5 cm,



Gerald  
EF-5-452-17  
Dissecting Forceps  
17.5 cm,



Cushing  
EF-5-453-17  
Dissecting Forceps  
18 cm,



Potts-Smith  
EF-5-454-18  
Dissecting Forceps  
18 cm, 21 cm, 24 cm,

# Dressing & Tissue Forceps

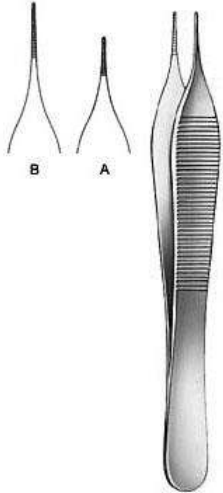

Mikro-Adson  
EF-5-455-12  
Dressing Forceps  
12 cm, 15 cm,

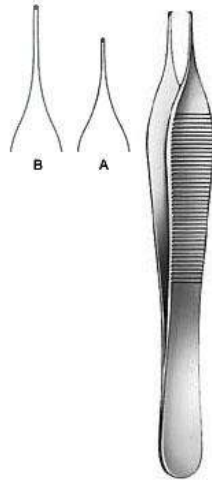

Mikro-Adson  
EF-5-456-12  
Dissecting Forceps  
12 cm, 15 cm,



EF-5-457-11  
Dissecting Forceps  
10.5 cm,



Micro Jewelers  
EF-5-458-12  
Jeweler Type Forceps  
12 cm Fig. 7,



Jewelers  
EF-5-459-12  
Jeweler Type Forceps  
12 cm Fig. 3,



Jewelers  
EF-5-460-11  
Jeweler Type Forceps  
11 cm Fig. 3c,

# Dressing & Tissue Forceps



Jewelers  
EF-5-461-11  
Jeweler Type Forceps  
11 cm Fig. 5,



Jewelers  
EF-5-462-11  
Jeweler Type Forceps  
11 cm Fig. 4,



Stille-Barraya  
EF-5-463-18  
Dissecting Forceps  
18 cm,



Bonney  
EF-5-464-18  
Dissecting Forceps  
17.5 cm,



Nelson  
EF-5-465-23  
Dissecting Forceps  
23 cm,



EF-5-466-10  
Dressing Forceps  
10 cm, 9.5 cm,



## Dressing & Tissue Forceps



EF-5-467-12  
Splinter Forceps smooth jaw  
12.5 cm,



EF-5-468-12  
Splinter Forceps smooth jaw  
12.5 cm,



EF-5-469-12  
Splinter Forceps  
12.5 cm,



EF-5-470-12  
Splinter Forceps  
12.5 cm,



EF-5-471-16  
Micro Tying Forceps  
15.5 cm,



EF-5-472-10  
Microscopic Forceps super light, blunt  
10 cm,

## Dressing & Tissue Forceps



EF-5-473-10  
Microscopic Forceps  
10 cm,



Shaaf  
EF-5-474-09  
Splinter Forceps  
9.5 cm,



Littauer  
EF-5-475-08  
Cilia Forceps  
8.5 cm,



EF-5-476-09  
Cilia Forceps  
8.5 cm,



Douglas  
EF-5-477-09  
Cilia Forceps  
9 cm,



Douglas  
EF-5-478-09  
Cilia Forceps  
9 cm,

## Dressing & Tissue Forceps

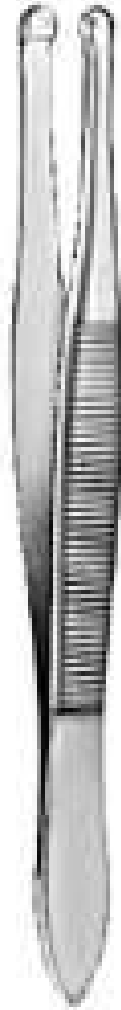

Beer

EF-5-479-09

Cilia Forceps

9 cm,

# Splinter Forceps



**Phaneuf**  
**EF-5-501-21**  
**Hysterectomy Forceps**  
 20.5 cm,



**Wertheim-Cullen**  
**EF-5-502-21**  
**Vaginal Clamp**  
 21 cm,

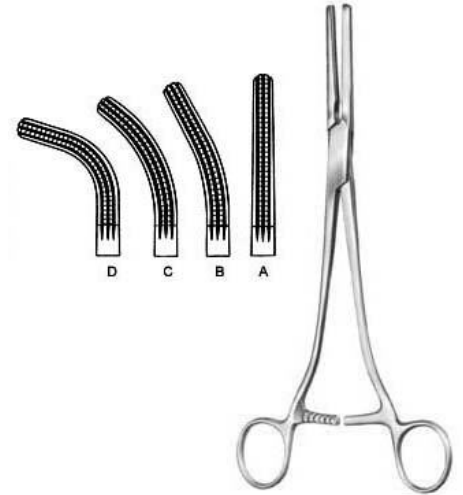

**Rogers**  
**EF-5-503-10**  
**Hysterectomy Forceps**  
 21.5 cm Fig. 1, 21 cm Fig. 2, 20.5 cm Fig. 3, 20 cm Fig. 4,



**Moynihan**  
**EF-5-504-23**  
**Hysterectomy Forceps**  
 23 cm,



**Moynihan**  
**EF-5-505-24**  
**Hysterectomy Forceps**  
 23.5 cm,



**Wertheim**  
**EF-5-506-25**  
**Hysterectomy Forceps**  
 26 cm,

# Splinter Forceps



**Phaneuf**  
**EF-5-501-21**  
**Hysterectomy Forceps**  
 20.5 cm,



**Wertheim-Cullen**  
**EF-5-502-21**  
**Vaginal Clamp**  
 21 cm,

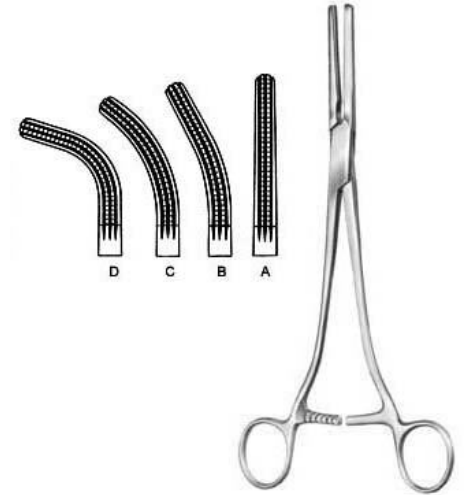

**Rogers**  
**EF-5-503-10**  
**Hysterectomy Forceps**  
 21.5 cm Fig. 1, 21 cm Fig. 2, 20.5 cm Fig. 3, 20 cm Fig. 4,



**Moynihan**  
**EF-5-504-23**  
**Hysterectomy Forceps**  
 23 cm,



**Moynihan**  
**EF-5-505-24**  
**Hysterectomy Forceps**  
 23.5 cm,



**Wertheim**  
**EF-5-506-25**  
**Hysterectomy Forceps**  
 26 cm,

# Splinter Forceps

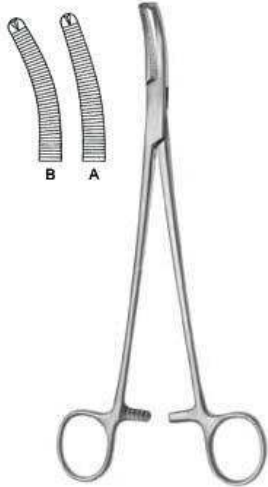

Wertheim  
EF-5-507-22  
Hysterectomy Forceps  
22.5 cm,



Mikulicz, Baby  
EF-5-508-14  
Peritoneum Forceps  
14.5 cm,



Mikulicz  
EF-5-509-18  
Peritoneum Forceps  
20.5 cm,



Mikulicz  
EF-5-510-20  
Peritoneum Forceps  
18.5 cm,



Mikulicz  
EF-5-511-20  
Peritoneum Forceps  
20 cm,



Mikulicz  
EF-5-512-21  
Peritoneum Forceps  
20.5 cm,

## Splinter Forceps



Faure

EF-5-513-20

Peritoneum Forceps

21 cm,

# Haemostatic Forceps

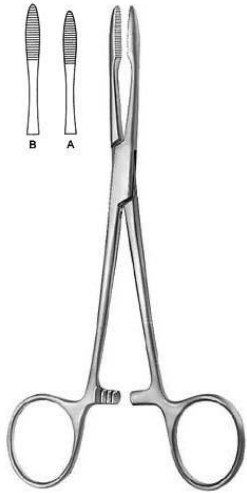

**Pean**  
**EF-5-601-14**  
**Haemostatic Forceps**  
 14.5 cm, 16 cm,

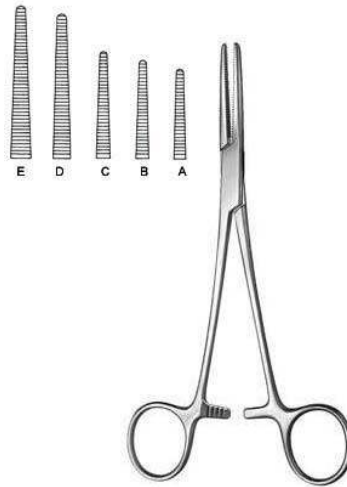

**Spencer-Wells**  
**EF-5-602-13**  
**Haemostatic Forceps**  
 13 cm, 14 cm, 15.5 cm, 18.5 cm, 20 cm,

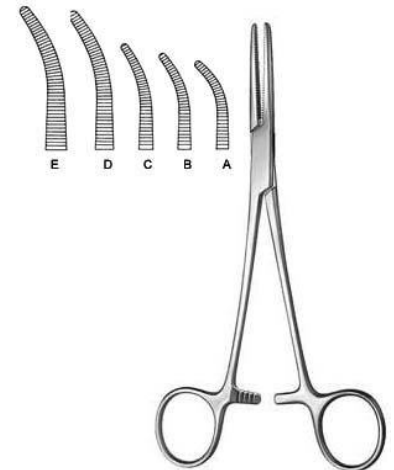

**Spencer-Wells**  
**EF-5-603-13**  
**Haemostatic Forceps**  
 13 cm, 14 cm, 15 cm, 18 cm, 20 cm,



**Chaput**  
**EF-5-604-13**  
**Haemostatic Forceps**



**Tuffier**  
**EF-5-605-13**  
**Haemostatic Forceps**

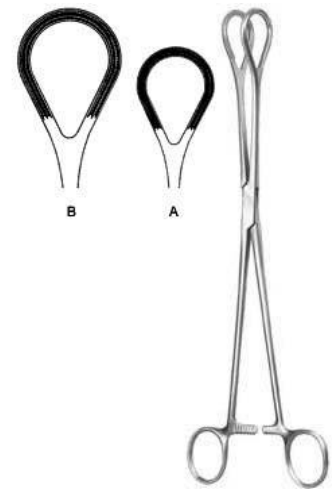

**EF-5-606-25**  
**Organ Grasping Forceps**



# Haemostatic Forceps



Collin  
EF-5-607-14  
Organ Grasping Forceps  
15.5 cm, 21 cm,



Collin  
EF-5-608-17  
Tumor Grasping Forceps  
17 cm,



Pennington  
EF-5-609-15  
Haemostatic Forceps  
15.5 cm,



Pratt  
EF-5-610-15  
Haemostatic Forceps  
15 cm,



Martel-Rees  
EF-5-611-14  
Face-lift Forceps  
13.5 cm,



EF-5-612-12  
Ligature Forceps

# Haemostatic Forceps



**Mixer-Baby**  
**EF-5-613-01**  
 Dissecting and Ligature Forceps  
 13.5 cm, 13 cm,

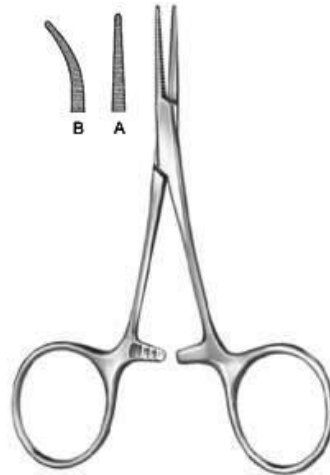

**Hartmann**  
**EF-5-614-10**  
 Haemostatic Forceps  
 10 cm, 9.5 cm,



**EF-5-615-12**  
 Ligature Forceps

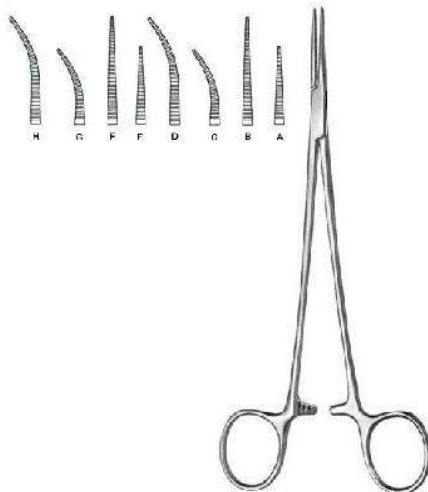

**Halsted-Mosquito**  
**EF-5-616-18**  
 Haemostatic Forceps  
 12.5 cm, 14.5 cm, 14 cm,

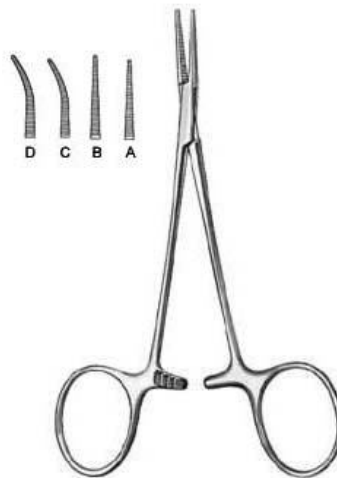

**Mikro-Mosquito**  
**EF-5-617-10**  
 Haemostatic Forceps  
 10 cm, 12 cm, 9.5 cm, 11.5 cm,



**Providence-Hospital**  
**EF-5-618-14**  
 Haemostatic Forceps  
 14 cm,

# Haemostatic Forceps



**Leriche**  
**EF-5-619-15**  
**Haemostatic Forceps**  
 15.5 cm, 15 cm,

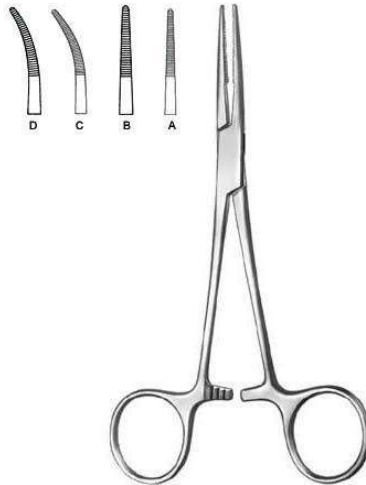

**Kelly**  
**EF-5-620-14**  
**Haemostatic Forceps**  
 14.5 cm, 14 cm,

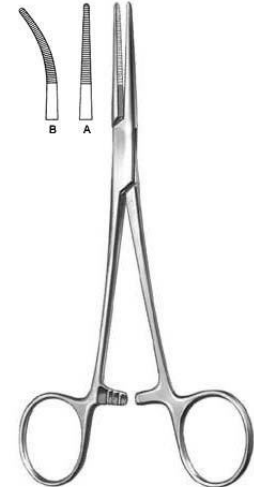

**Kelly-Rankin**  
**EF-5-621-16**  
**Haemostatic Forceps**  
 16 cm, 15.5 cm,



**Overholt-Baby**  
**EF-5-622-14**  
**Dissecting and Ligature Forceps**  
 14.5 cm, 14 cm,



**Crile**  
**EF-5-623-14**  
**Haemostatic Forceps**  
 14.5 cm, 14 cm,



**Crile-Rankin**  
**EF-5-624-16**  
**Haemostatic Forceps**  
 16.5 cm, 16 cm,

# Haemostatic Forceps

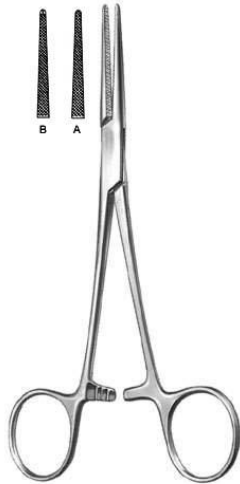

Lovelace  
EF-5-625-15  
Haemostatic Forceps  
16 cm,



Dandy-Mosquito  
EF-5-626-12  
Haemostatic Forceps  
12 cm,

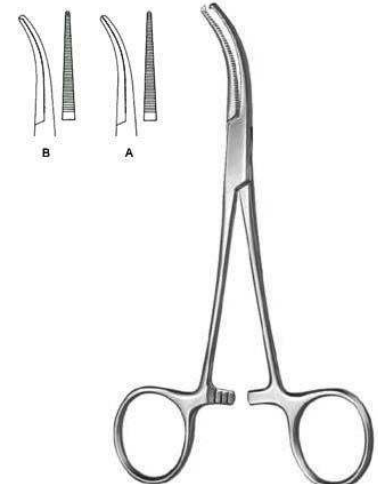

Dandy  
EF-5-627-14  
Haemostatic Forceps  
14.5 cm, 14 cm,



Schnidt  
EF-5-628-18  
Dissecting and Ligature Forceps  
18.5 cm, 19 cm,



Adson  
EF-5-629-18  
Dissecting and Ligature Forceps  
19 cm, 18.5 cm,



Martin-Fuchsig  
EF-5-630-20  
Dissecting and Ligature Forceps  
20.5 cm,

# Haemostatic Forceps

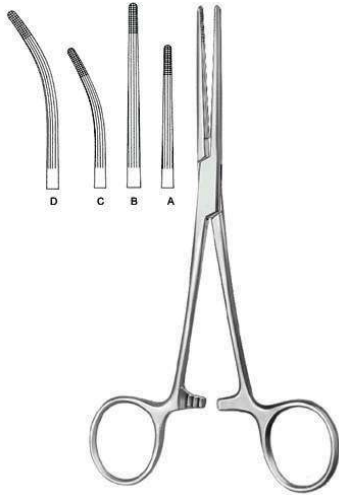

**Rochester-Carmalt**  
**EF-5-631-16**  
**Haemostatic Forceps**  
 17 cm, 20.5 cm, 16.5 cm, 20 cm,

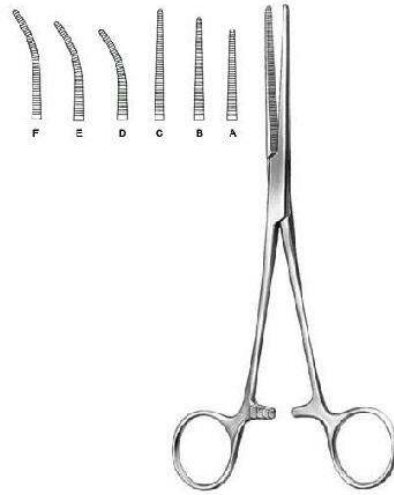

**Pean**  
**EF-5-632-13**  
**Haemostatic Forceps**  
 13.5 cm, 14.5 cm, 17 cm, 13 cm, 14 cm, 16.5 cm,

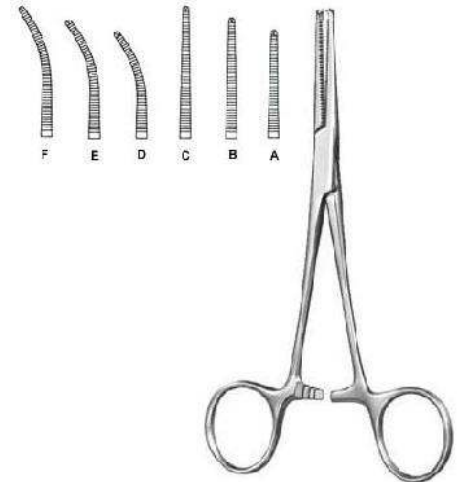

**Kocher-Nippon**  
**EF-5-633-14**  
**Haemostatic Forceps**  
 14.5 cm, 16.5 cm, 18.5 cm, 16 cm, 18 cm,

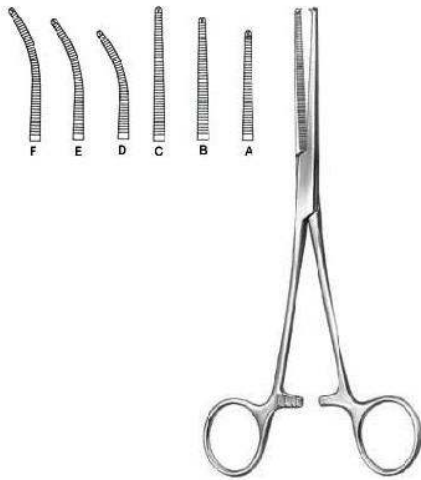

**Kocher**  
**EF-5-635-13**  
**Haemostatic Forceps**  
 13 cm, 14 cm, 16 cm,

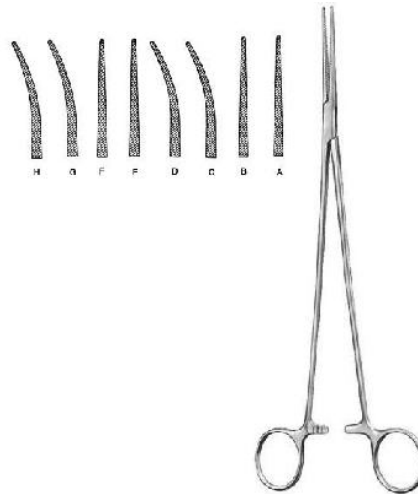

**Bengolea**  
**EF-5-636-20**  
**Haemostatic Forceps**  
 21.5 cm, 26 cm, 21 cm, 21.5 cm,

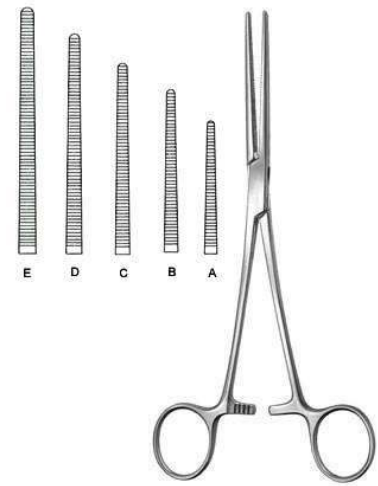

**Pean (Rochester)**  
**EF-5-637-14**  
**Haemostatic Forceps**  
 14.5 cm, 16.5 cm, 18.5 cm, 20.5 cm, 22.5 cm, 24.5 cm, 26 cm, 30.5 cm, 14 cm, 16 cm,

# Haemostatic Forceps

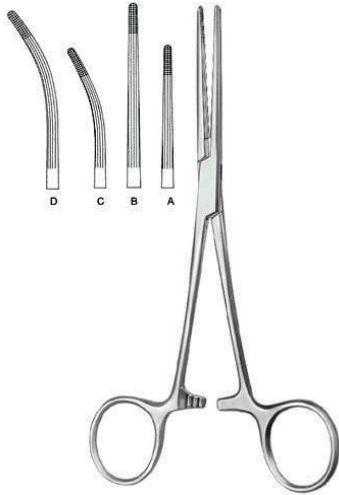

**Rochester-Carmalt**  
**EF-5-631-16**  
**Haemostatic Forceps**  
 17 cm, 20.5 cm, 16.5 cm, 20 cm,

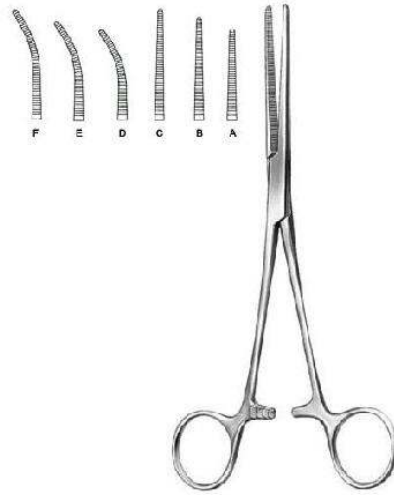

**Pean**  
**EF-5-632-13**  
**Haemostatic Forceps**  
 13.5 cm, 14.5 cm, 17 cm, 13 cm, 14 cm, 16.5 cm,

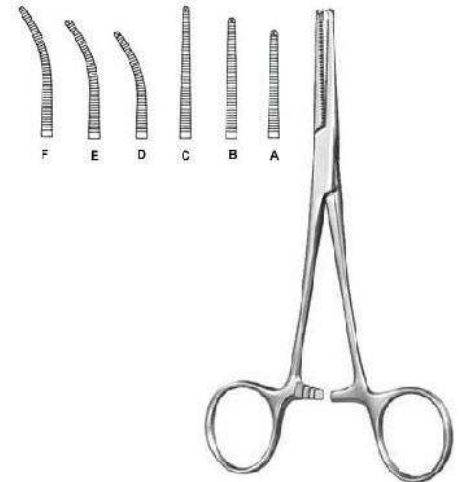

**Kocher-Nippon**  
**EF-5-633-14**  
**Haemostatic Forceps**  
 14.5 cm, 16.5 cm, 18.5 cm, 16 cm, 18 cm,

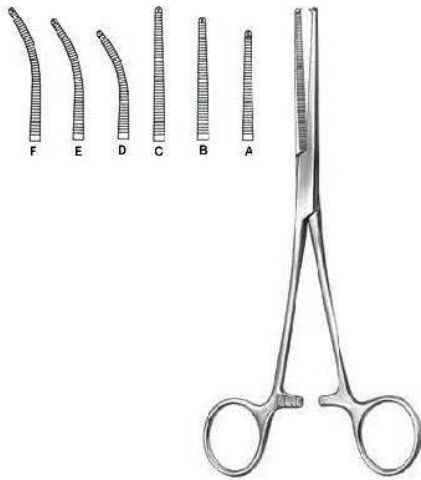

**Kocher**  
**EF-5-635-13**  
**Haemostatic Forceps**  
 13 cm, 14 cm, 16 cm,

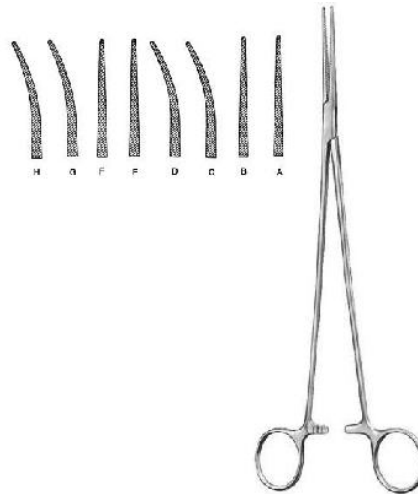

**Bengolea**  
**EF-5-636-20**  
**Haemostatic Forceps**  
 21.5 cm, 26 cm, 21 cm, 21.5 cm,

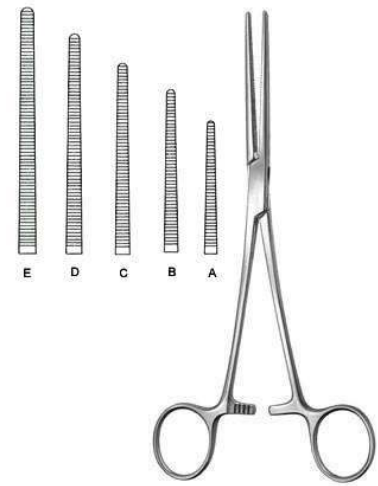

**Pean (Rochester)**  
**EF-5-637-14**  
**Haemostatic Forceps**  
 14.5 cm, 16.5 cm, 18.5 cm, 20.5 cm, 22.5 cm, 24.5 cm, 26 cm, 30.5 cm, 14 cm, 16 cm,

# Haemostatic Forceps

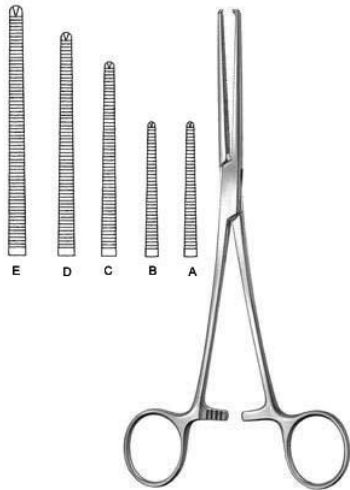

**Kocher (Ochsner)**  
EF-5-638-14

Haemostatic Forceps  
14.5 cm, 16.5 cm, 18.5 cm, 20.5 cm, 22.5 cm, 24.5 cm, 26 cm, 30.5 cm,

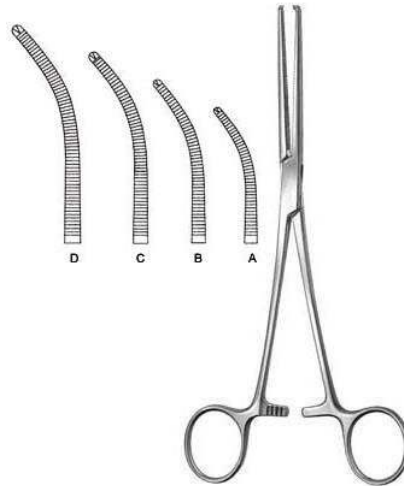

**Kocher (Ochsner)**  
EF-5-639-14

Haemostatic Forceps  
14 cm, 16 cm, 18 cm, 20 cm, 22 cm, 24 cm, 25.5 cm, 30 cm,

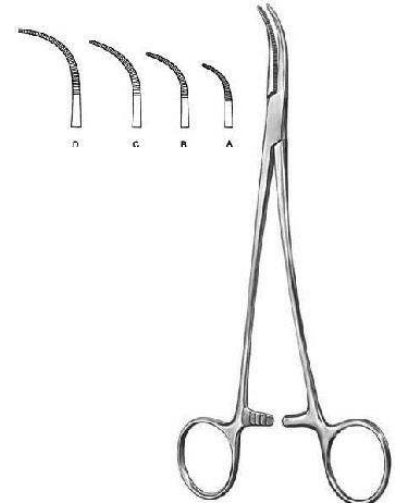

**Overholt-Martin**  
EF-5-640-01

Dissecting and Ligature Forceps  
18.5 cm Fig. 1, 20.5 cm Fig. 2, 21 cm Fig. 3, 21.5 cm Fig. 4, 24.5 cm Fig. 5,



**Mixer-Baby**  
EF-5-641-18

Dissecting and Ligature Forceps  
18.5 cm,



**Adson-Baby**  
EF-5-642-14

Dissecting and Ligature Forceps  
14.5 cm, 18 cm,



**Heiss**  
EF-5-643-20

Dissecting and Ligature Forceps  
21 cm, 20.5 cm, 20 cm,

# Haemostatic Forceps



**Overholt-Mixer**  
EF-5-644-21

Dissecting and Ligature Forceps  
21.5 cm,

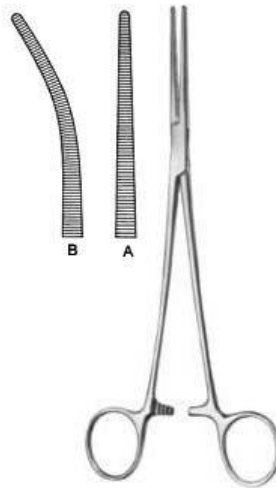

**Roberts**

EF-5-645-22

Dissecting and Ligature Forceps  
22.5 cm, 21.5 cm,

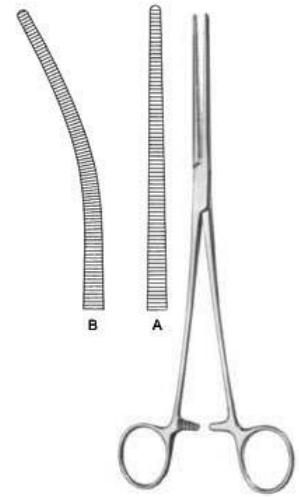

**Sarot**

EF-5-646-24

Dissecting and Ligature Forceps  
25 cm, 24.5 cm,

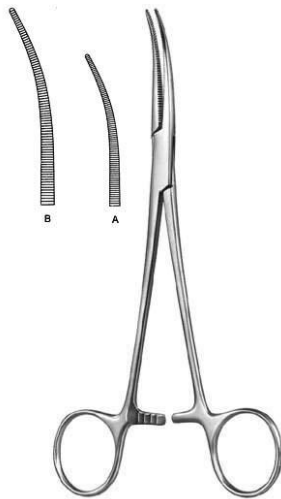

**Crafoord**

EF-5-647-18

Dissecting and Ligature Forceps  
18 cm, 24.5 cm,

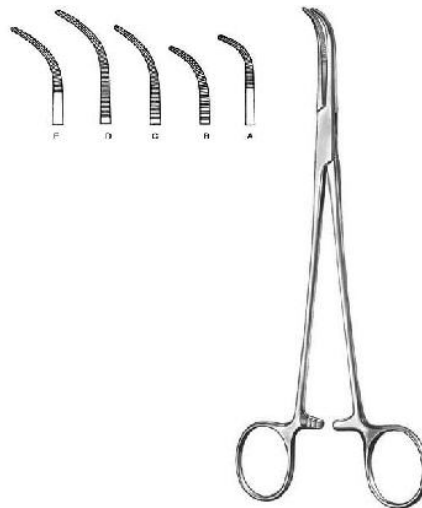

**Overholt-Geissendorfer**

EF-5-648-01

Dissecting and Ligature Forceps  
20.5 cm Fig. 1, 20 cm Fig. 2, 21.5 cm Fig. 3, 22 cm Fig. 4, 21.5 cm Fig. 5, 22 cm Fig. 6, 27 cm Fig. 1, 26.5 cm Fig. 2, 27.5 cm Fig. 3, 28 cm Fig. 4,

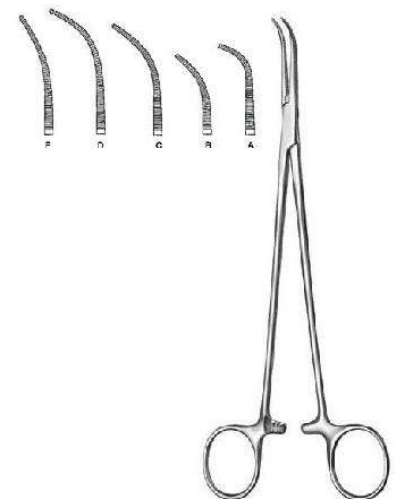

**Overholt-Fino**

EF-5-649-00

Dissecting and Ligature Forceps  
21.5 cm, 21 cm, 22 cm, 23 cm, 22.5 cm,



# Haemostatic Forceps

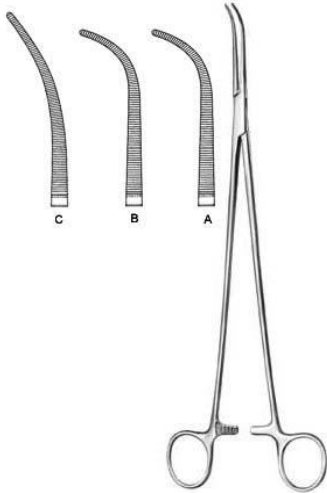

**Overholt**  
EF-5-650-00  
Dissecting and Ligature Forceps  
29.5 cm, 30 cm,



**Overholt-Mini**  
EF-5-651-01  
Dissecting and Ligature Forceps  
15 cm, 20 cm,

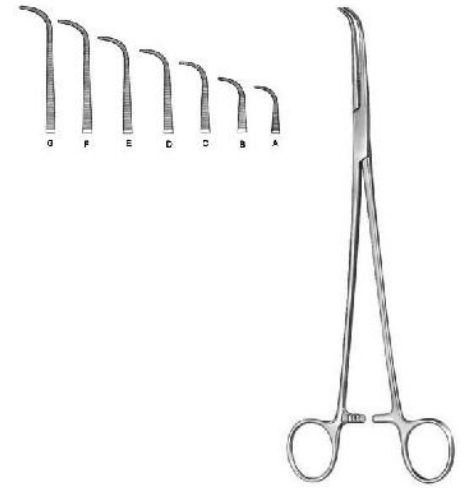

**Gemini**  
EF-5-652-13  
Dissecting and Ligature Forceps  
13 cm, 16 cm, 18 cm, 21 cm, 23 cm, 25 cm, 28 cm,

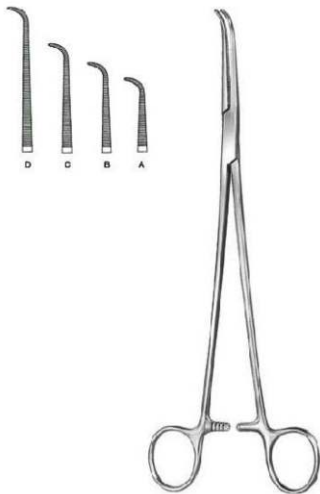

**Mini-Gemini**  
EF-5-653-18  
Dissecting and Ligature Forceps  
18 cm, 22.5 cm, 25 cm, 28.5 cm,

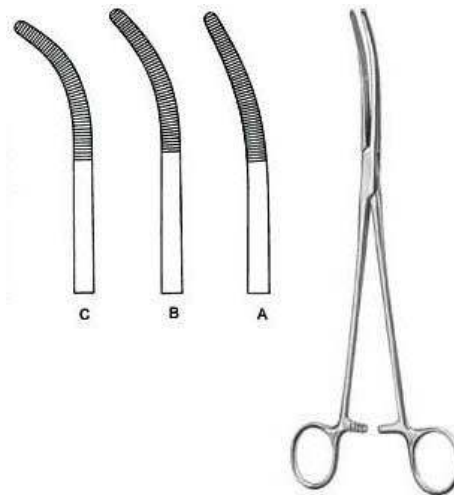

**Rumel**  
EF-5-654-01  
Dissecting and Ligature Forceps  
24 cm Fig. 1, 23.5 cm Fig. 2, 23 cm Fig. 3, 24 cm Fig. 4, 23.5 cm Fig. 5,

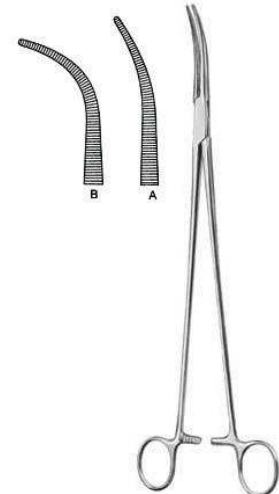

**Zenker**  
EF-5-655-01  
Dissecting and Ligature Forceps  
29.5 cm, 28.5 cm,

# Haemostatic Forceps



**Mixer-Baby**  
**EF-5-656-14**  
 Dissecting and Ligature Forceps  
 13.5 cm,



**Mixer**  
**EF-5-657-15**  
 Dissecting and Ligature Forceps  
 16 cm, 18 cm,



**Mixer-O Shaugnessy**  
**EF-5-658-19**  
 Dissecting and Ligature Forceps  
 18 cm,



**Mixer**  
**EF-5-659-22**  
 Dissecting and Ligature Forceps  
 22.5 cm,



**Mixer**  
**EF-5-660-23**  
 Dissecting and Ligature Forceps  
 23 cm,

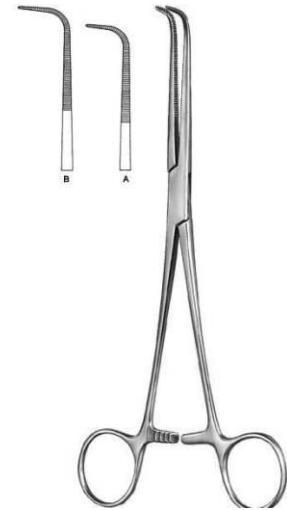

**Wickstrom**  
**EF-5-661-21**  
 Dissecting and Ligature Forceps  
 21 cm, 24.5 cm,

# Haemostatic Forceps

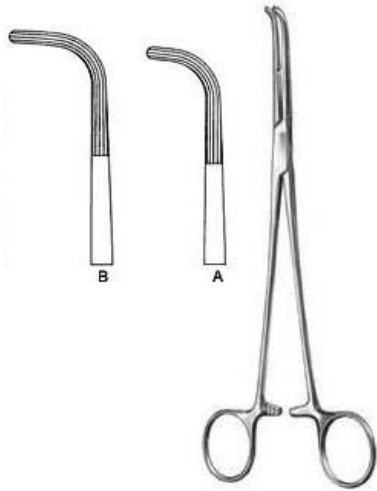

**Mixer**  
**EF-5-662-22**  
 Dissecting and Ligature Forceps  
 22.5 cm, 26 cm, 28 cm,



**Mc Quigg-Mixer**  
**EF-5-663-22**  
 Dissecting and Ligature Forceps  
 23.5 cm,



**Lower**  
**EF-5-664-18**  
 Dissecting and Ligature Forceps  
 18.5 cm,

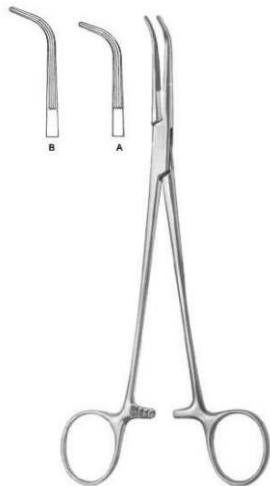

**Lahey**  
**EF-5-665-19**  
 Bile Duct Clamp  
 19.5 cm, 22.5 cm,



**Finochietto**  
**EF-5-666-24**  
 Dissecting and Ligature Forceps  
 24 cm,

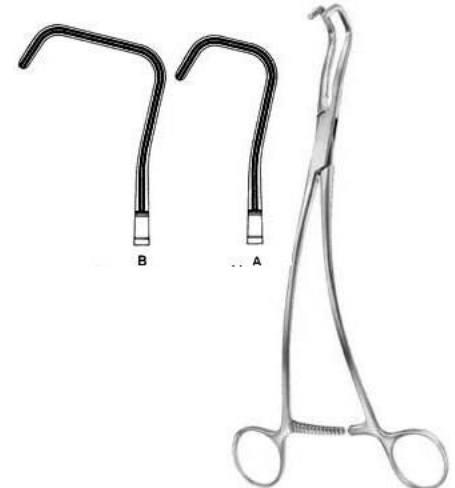

**Uro-Tangential**  
**EF-5-667-01**  
 Tangential Forceps  
 25 cm, 27 cm,

# Haemostatic Forceps

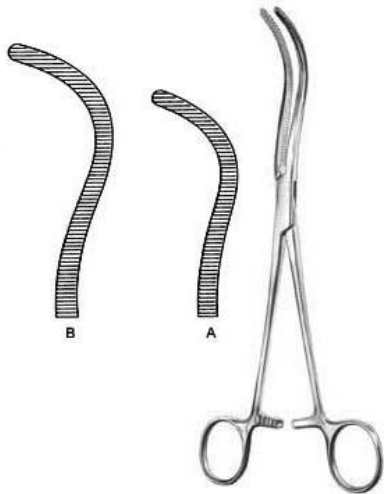

**Guyon**  
**EF-5-668-20**  
 Kidney Pedicle Clamp  
 23 cm, 24 cm,



**Guyon**  
**EF-5-669-23**  
 Kidney Pedicle Clamp  
 19.5 cm, 21.5 cm, 24 cm,



**Desjardins**  
**EF-5-670-21**  
 Bile Duct Clamp  
 21 cm,

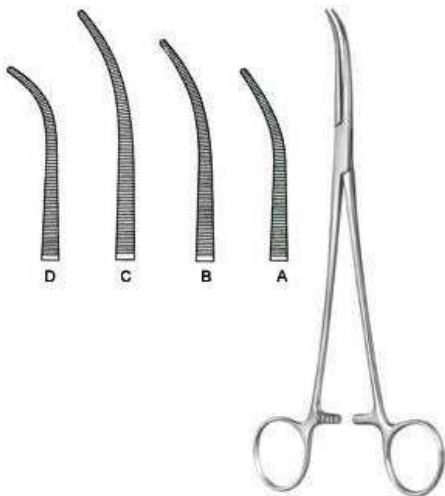

**Kelly**  
**EF-5-671-19**  
 Dissecting and Ligature Forceps  
 19.5 cm Fig. 1, 22.5 cm Fig. 1, 24.5 cm Fig. 1,  
 19 cm Fig. 2, 22 cm Fig. 2, 24 cm Fig. 2, 18.5  
 cm Fig. 3, 21.5 cm Fig. 3, 23.5 cm Fig. 3,



**Lawrence**  
**EF-5-672-28**  
 Dissecting and Ligature Forceps  
 28 cm,



**Meeker**  
**EF-5-673-28**  
 Dissecting and Ligature Forceps  
 28 cm,

## Haemostatic Forceps



Negus

EF-5-674-19

Haemostatic Forceps

19.5 cm Fig. 1, 20 cm Fig. 2,

# Towel & Tubing Clamps



Schaedel  
EF-5-701-09  
Towel Clamp sharp  
9 cm,



Jones  
EF-5-702-05  
Towel Clamp sharp  
5.5 cm, 8.5 cm,



Jones-Martin  
EF-5-703-09  
Towel Clamp sharp  
8.5 cm,



Backhaus  
EF-5-704-11  
Towel Clamp  
11.5 cm, 13 cm,



Backhaus  
EF-5-705-11  
Towel Clamp  
11.5 cm,



Backhaus  
EF-5-706-08  
Towel Clamp  
9 cm, 11.5 cm, 13 cm, 16 cm,

# Towel & Tubing Clamps

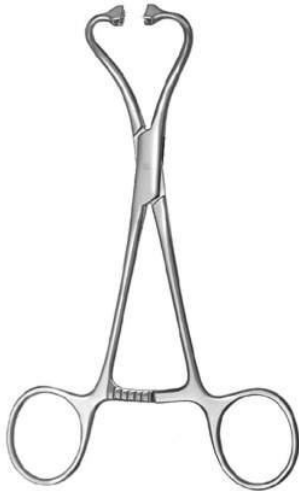

Peers-Bertram modif.  
EF-5-707-15  
Towel Clamp wide jaw for tube fixation  
15.5 cm,



R?der  
EF-5-708-13  
Towel Clamp  
13.5 cm,

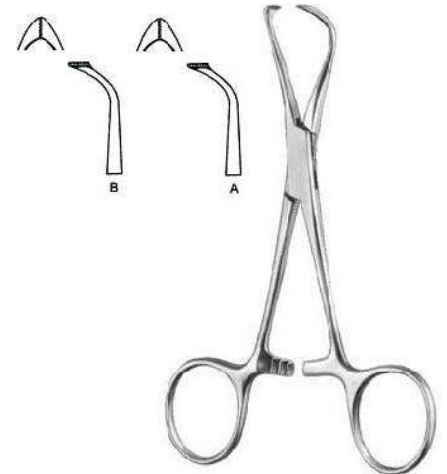

Lorna  
EF-5-709-10  
Towel Clamp fine serrated, wide jaw  
9.5 cm, 13 cm,



Bernhard  
EF-5-710-16  
Towel Clamp  
16.5 cm,

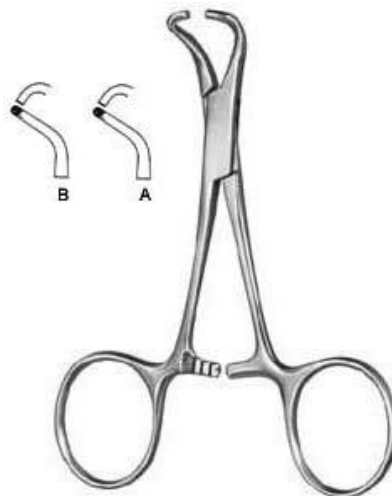

Tohoku  
EF-5-711-10  
Towel Clamp  
10.5 cm blunt, 13.5 cm blunt, 14.5 cm,

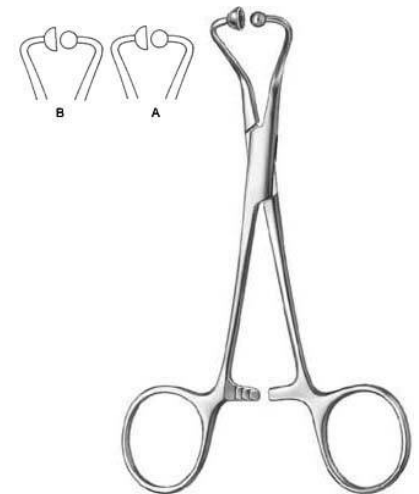

EF-5-712-11  
Towel Clamp for paper clothes  
11.5 cm, 14 cm,

# Towel & Tubing Clamps



Lane  
EF-5-713-20  
Towel Clamp  
19.5 cm,



EF-5-714-06  
Tube Holder for fixation of six tubes



EF-5-715-14  
Tubing Clamp extra long ratchet  
14 cm,



EF-5-716-16  
Tubing Clamp  
16.5 cm,

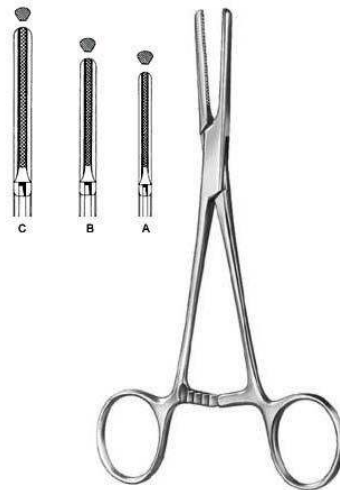

EF-5-717-15  
Tubing Clamp  
15.5 cm, 19 cm, 20.5 cm,

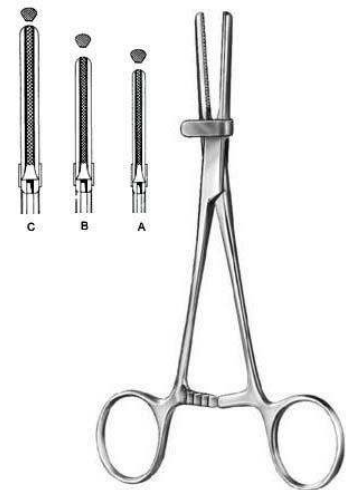

EF-5-718-15  
Tubing Clamp with safety guard  
15.5 cm, 19 cm, 20.5 cm,



# Dressing & Sponge Forceps

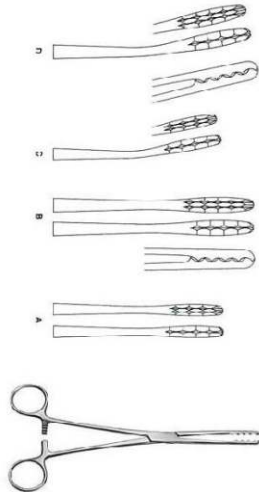

**Ulrich**  
**EF-5-801-22**  
 Dressing Forceps  
 22.5 cm, 26.5 cm,

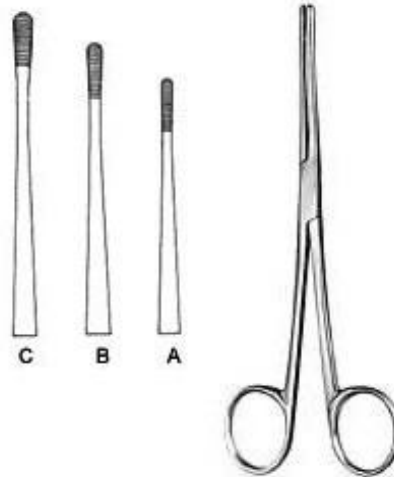

**Lister**  
**EF-5-802-13**  
 Sinus Forceps  
 13 cm, 16 cm, 18 cm,



**Martin**  
**EF-5-803-17**  
 Dressing Forceps  
 17.5 cm, 17 cm,

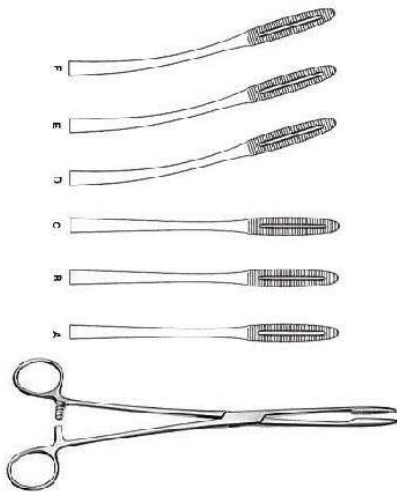

**Gross-Maier**  
**EF-5-804-20**  
 Dressing Forceps  
 20.5 cm, 22 cm, 26.5 cm, 20 cm, 21.5 cm, 26 cm,



**EF-5-805-40**  
 Tunneling Forceps  
 39.5 cm,



**Collin**  
**EF-5-806-25**  
 Dressing Forceps  
 25.5 cm,

# Towel & Tubing Clamps



Lane  
EF-5-713-20  
Towel Clamp  
19.5 cm,



EF-5-714-06  
Tube Holder for fixation of six tubes



EF-5-715-14  
Tubing Clamp extra long ratchet  
14 cm,



EF-5-716-16  
Tubing Clamp  
16.5 cm,

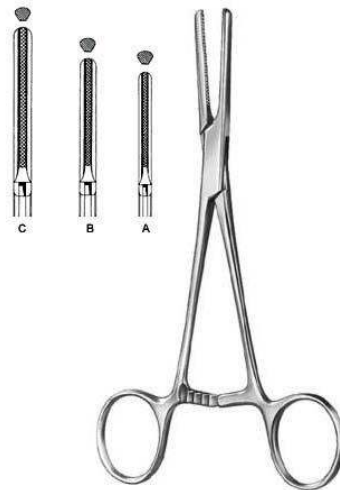

EF-5-717-15  
Tubing Clamp  
15.5 cm, 19 cm, 20.5 cm,

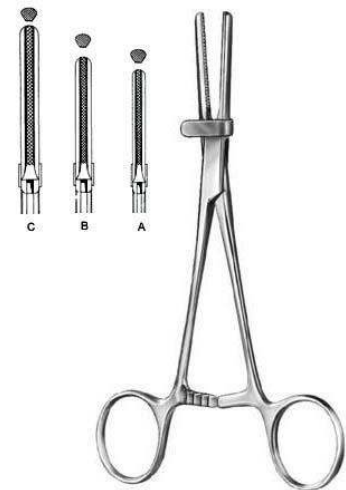

EF-5-718-15  
Tubing Clamp with safety guard  
15.5 cm, 19 cm, 20.5 cm,

# Dressing & Sponge Forceps

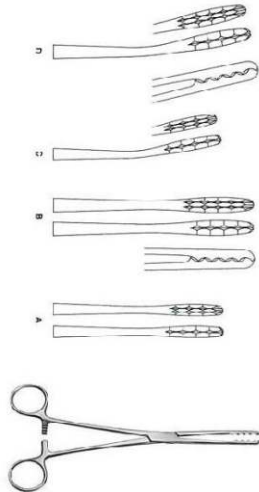

**Ulrich**  
**EF-5-801-22**  
 Dressing Forceps  
 22.5 cm, 26.5 cm,

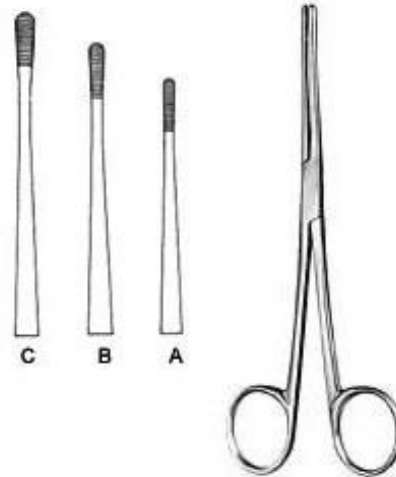

**Lister**  
**EF-5-802-13**  
 Sinus Forceps  
 13 cm, 16 cm, 18 cm,



**Martin**  
**EF-5-803-17**  
 Dressing Forceps  
 17.5 cm, 17 cm,

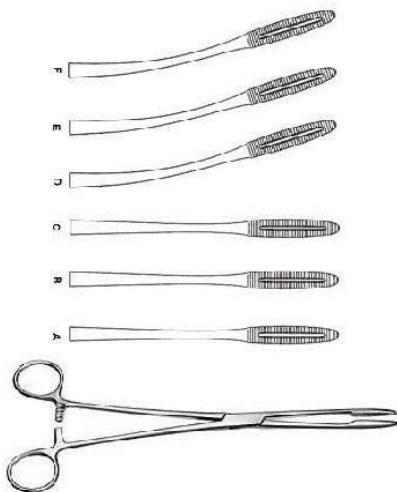

**Gross-Maier**  
**EF-5-804-20**  
 Dressing Forceps  
 20.5 cm, 22 cm, 26.5 cm, 20 cm, 21.5 cm, 26 cm,



**EF-5-805-40**  
 Tunneling Forceps  
 39.5 cm,



**Collin**  
**EF-5-806-25**  
 Dressing Forceps  
 25.5 cm,

# Dressing & Sponge Forceps

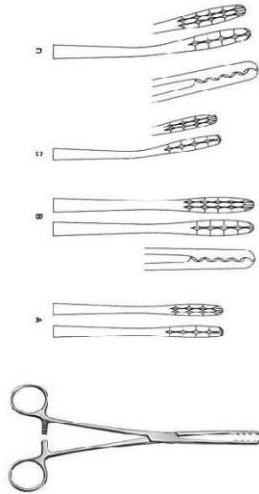

**Ulrich**  
**EF-5-801-22**  
 Dressing Forceps  
 22.5 cm, 26.5 cm,

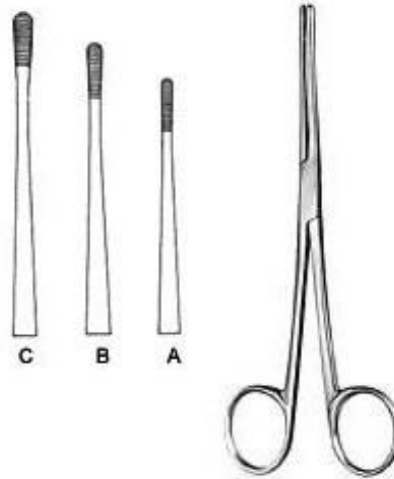

**Lister**  
**EF-5-802-13**  
 Sinus Forceps  
 13 cm, 16 cm, 18 cm,



**Martin**  
**EF-5-803-17**  
 Dressing Forceps  
 17.5 cm, 17 cm,

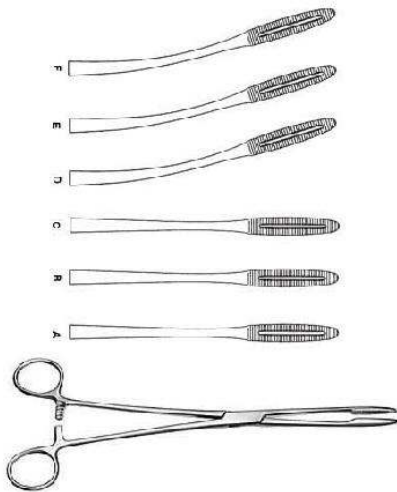

**Gross-Maier**  
**EF-5-804-20**  
 Dressing Forceps  
 20.5 cm, 22 cm, 26.5 cm, 20 cm, 21.5 cm, 26 cm,



**EF-5-805-40**  
 Tunneling Forceps  
 39.5 cm,



**Collin**  
**EF-5-806-25**  
 Dressing Forceps  
 25.5 cm,



Cheron  
EF-5-807-25  
Dressing Forceps  
23.5 cm,

# Retractors



Vickers  
EF-5-901-18  
Skin Hooklet  
18.5 cm,



Vickers  
EF-5-902-01  
Bone Hooklet  
17 cm,



Vickers  
EF-5-903-01  
Tendon Hooklet  
17 cm,



Vickers  
EF-5-904-02  
Hooklet  
16 cm,

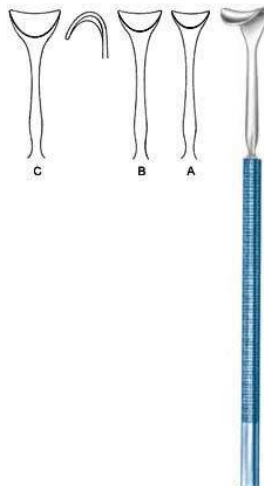

Vickers  
EF-5-905-12  
Saddle Hook  
14 cm,



Graefe  
EF-5-906-01  
Micro Hooklet  
15 cm,

# Retractors

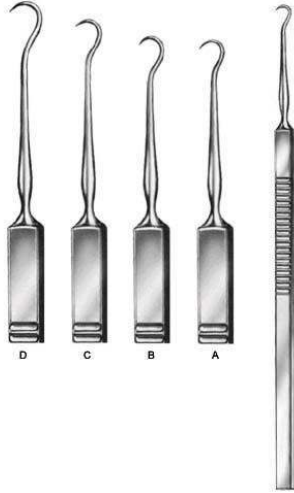

EF-5-907-01  
Skin Hook  
16 cm Fig. 1, 16 cm Fig. 2, 16 cm Fig. 3, 16 cm Fig. 4,



O Connor  
EF-5-908-16  
Skin Hook  
16 cm,

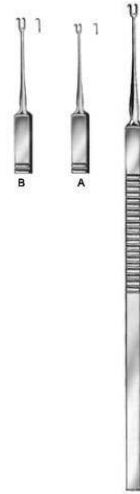

Guthrie  
EF-5-909-01  
Skin Hook  
15.5 cm,

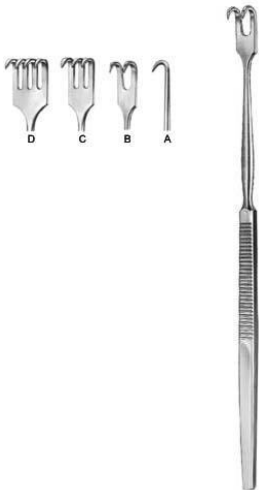

EF-5-910-01  
Hooklet  
16.5 cm,

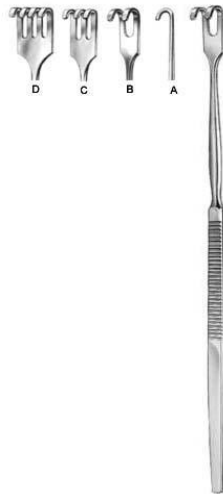

EF-5-911-01  
Hooklet  
16.5 cm,



EF-5-912-02  
Hooklet  
16 cm,

# Retractors



EF-5-913-04  
Hooklet  
16.5 cm,



EF-5-914-12  
Vessel Hook  
12 cm,

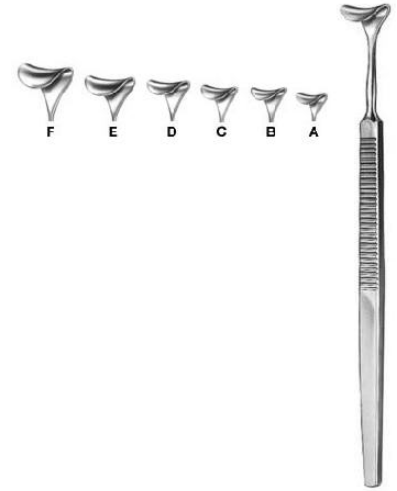

Desmarres  
EF-5-915-08  
Saddle Hook  
16 cm 8 mm, 16 cm 10 mm, 16 cm 12 mm, 16 cm 14 mm, 16 cm 16 mm, 16 cm 18 mm,

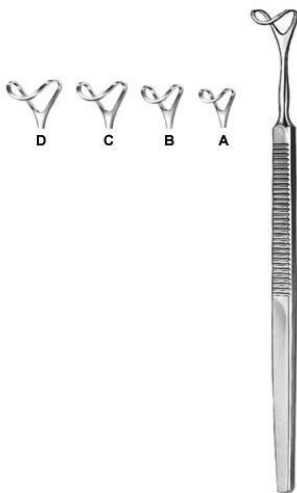

EF-5-916-12  
Saddle Hook  
16 cm 12 mm, 16 cm 14 mm, 16 cm 16 mm, 16 cm 18 mm,

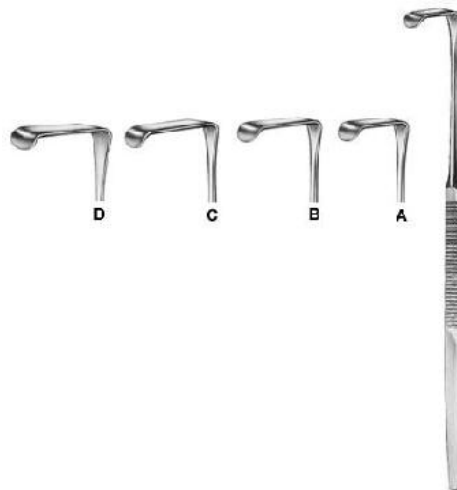

Langenbeck-Mini  
EF-5-917-10  
Hooklet  
16 cm,



EF-5-918-16  
Hooklet  
16 cm 14 x 8,



# Retractors



EF-5-919-01  
Hooklet  
16.5 cm,



EF-5-920-01  
Hooklet  
16.5 cm,



Meyerding  
EF-5-921-01  
Hooklet  
17.5 cm Fig. 1, 17.5 cm Fig. 2, 17.5 cm Fig. 3, 17.5 cm Fig. 4, 17.5 cm Fig. 5, 17.5 cm Fig. 6,



Senn-Green  
EF-5-922-01  
Hooklet  
15 cm Fig. 1, 15 cm Fig. 2,



Ragnell-Davis  
EF-5-923-14  
Hooklet  
14 cm,

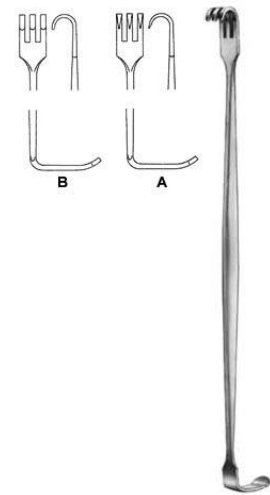

Senn-Miller  
EF-5-924-16  
Hooklet  
16 cm,

# Retractors



Cushing  
EF-5-925-20  
Retractor  
20.5 cm,

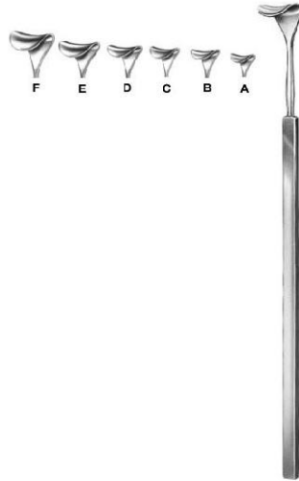

Cushing  
EF-5-926-08  
Saddle Hook  
20.5 cm 8 mm wide, 20.5 cm 10 mm wide, 20.5 cm 12 mm wide, 20.5 cm 14 mm wide, 20.5 cm 16 mm wide, 20.5 cm 18 mm wide,

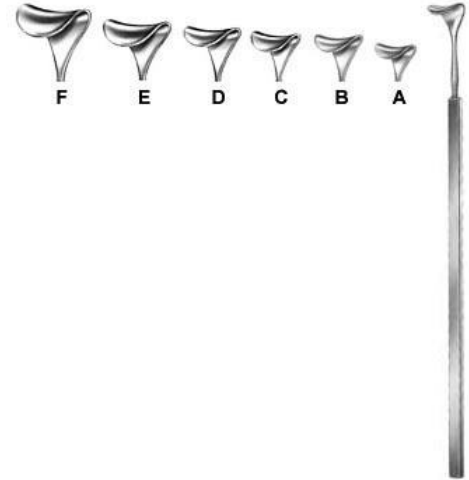

Cushing  
EF-5-927-08  
Saddle Hook 8 mm to 18 mm wide  
24 cm,



Brom  
EF-5-928-01  
Vein Hook  
19.5 cm,



Strandell-Stille  
EF-5-929-01  
Hooklet  
19 cm Fig. 1, 19 cm Fig. 2,



Klapp  
EF-5-930-01  
Retractor 12 x 6, 12 x 11, 15 x 11  
17.5 cm,

# Retractors



Cushing  
EF-5-925-20  
Retractor  
20.5 cm,

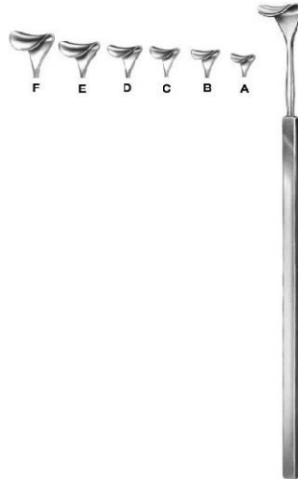

Cushing  
EF-5-926-08  
Saddle Hook  
20.5 cm 8 mm wide, 20.5 cm 10 mm wide, 20.5 cm 12 mm wide, 20.5 cm 14 mm wide, 20.5 cm 16 mm wide, 20.5 cm 18 mm wide,

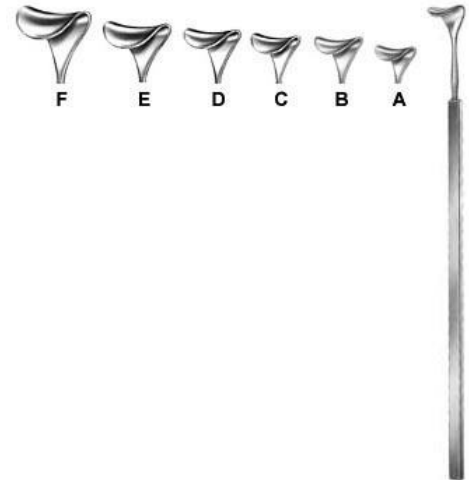

Cushing  
EF-5-927-08  
Saddle Hook 8 mm to 18 mm wide  
24 cm,



Brom  
EF-5-928-01  
Vein Hook  
19.5 cm,



Strandell-Stille  
EF-5-929-01  
Hooklet  
19 cm Fig. 1, 19 cm Fig. 2,



Klapp  
EF-5-930-01  
Retractor 12 x 6, 12 x 11, 15 x 11  
17.5 cm,

# Retractors



**EF-5-931-04**  
Hooklet  
16.5 cm,

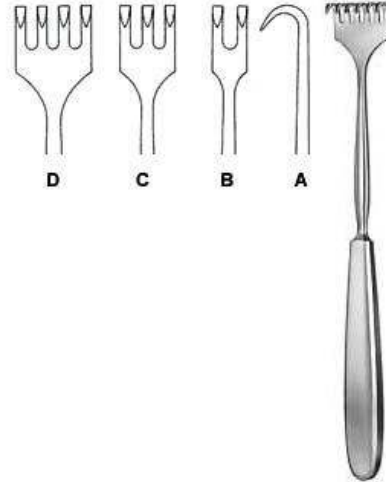

**Volkmann**  
**EF-5-932-01**  
Retractor  
21.5 cm,

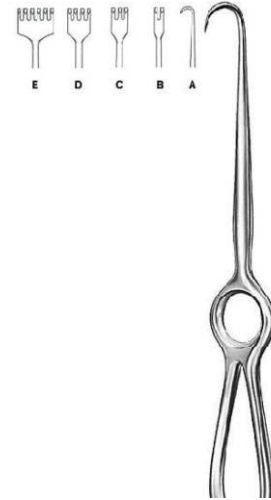

**Volkmann**  
**EF-5-933-01**  
Retractor  
22 cm, 21.5 cm,



**Kocher**  
**EF-5-934-01**  
Retractor  
22 cm,

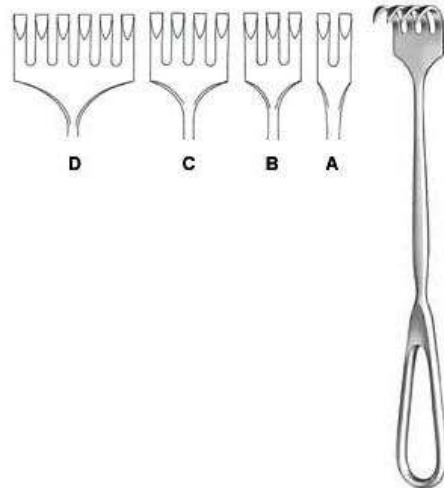

**Martin**  
**EF-5-935-02**  
Retractor  
22.5 cm,

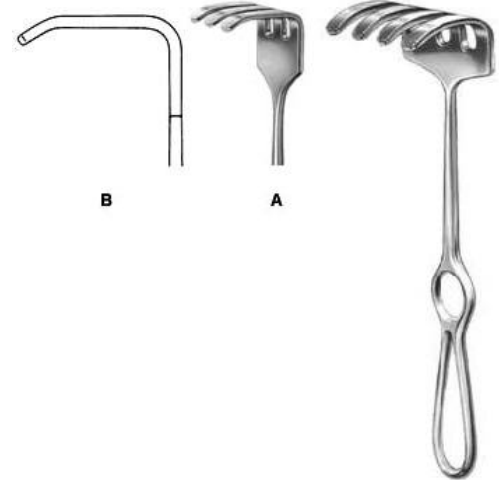

**Ollier**  
**EF-5-936-03**  
Retractor  
23 cm 36 x 30, 23 cm 36 x 60,

# Retractors



Wassmund  
EF-5-937-02  
Retractor  
20.5 cm 33 x 21,

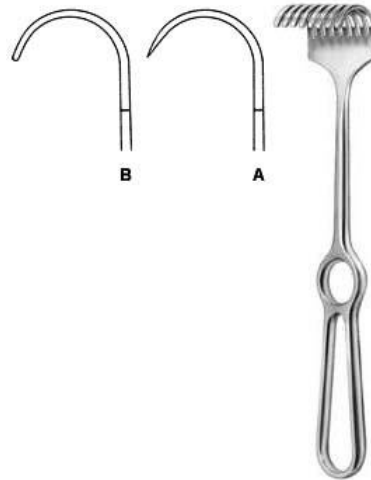

Korte  
EF-5-938-08  
Retractor  
24.5 cm 40 x 30,

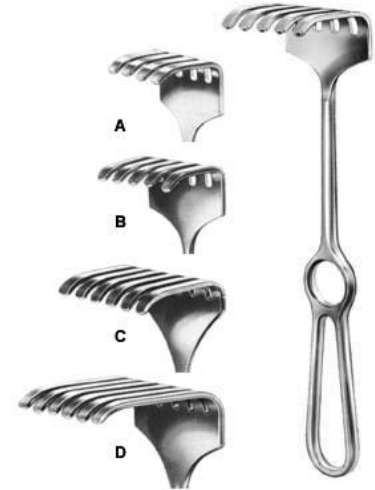

Israel  
EF-5-939-04  
Retractor  
25.5 cm,

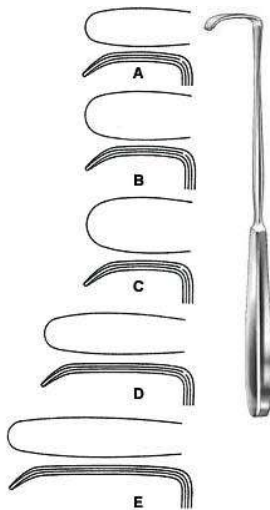

Langenbeck  
EF-5-940-01  
Retractor  
22.5 cm 30 x 11 mm, 22.5 cm 30 x 14 mm, 22.5 cm 30 x 16 mm, 22.5 cm 40 x 11 mm, 22.5 cm 50 x 11 mm,

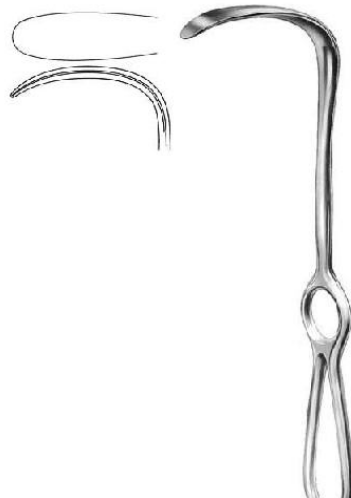

Langenbeck  
EF-5-942-21  
Retractor  
21 cm 65 x 20 mm,



Langenbeck  
EF-5-943-21  
Retractor  
22.5 cm 85 x 15 mm,

# Retractors



**Lahey**  
EF-5-944-19  
Retractor  
19.5 cm 36 x 19 mm,



**Little**  
EF-5-945-20  
Retractor  
20 cm 13 x 15 mm,

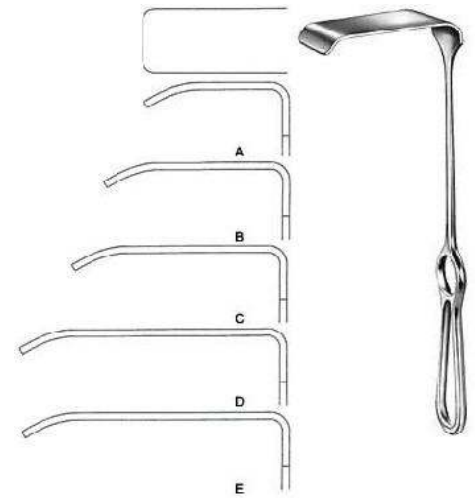

**Kocher**  
EF-5-946-18  
Retractor  
23 cm 43 x 18 mm, 23 cm 53 x 20 mm, 23 cm  
63 x 25 mm, 23 cm 77 x 30 mm, 23 cm 78 x  
40 mm,

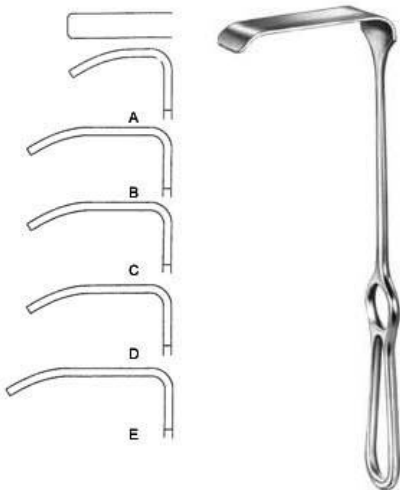

**Kocher-Langenbeck**  
EF-5-947-01  
Retractor  
21.5 cm 25 x 6 mm, 21.5 cm 35 x 8 mm, 21.5  
cm 35 x 11 mm, 21.5 cm 35 x 15 mm, 21.5 cm  
40 x 11 mm, 21.5 cm 55 x 11 mm, 21.5 cm 70  
x 14 mm, 21.5 cm 80 x 12 mm,

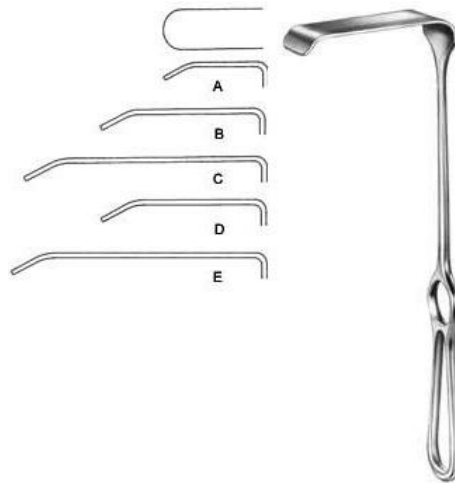

**Kocher-Langenbeck**  
EF-5-948-01  
Retractor  
21.5 cm 25 x 10 mm, 21.5 cm 40 x 13  
mm, 21.5 cm 60 x 13 mm, 21.5 cm 40 x 18  
mm, 21.5 cm 60 x 18 mm, 21.5 cm 85 x 18  
mm, 21.5 cm 60 x 25 mm, 21.5 cm 85 x 25  
mm,

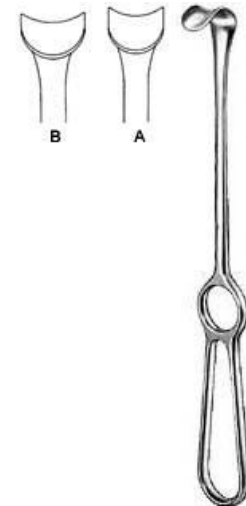

**Kocher**  
EF-5-949-01  
Retractor  
21.5 cm 22 x 12 mm, 21.5 cm 24 x 14 mm,

# Retractors

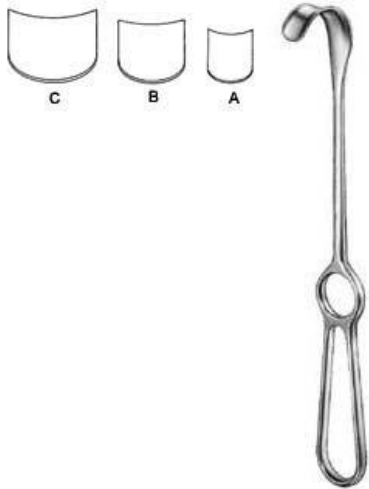

**Kocher**  
**EF-5-950-01**  
**Retractor**  
 22 cm 42 x 10 mm, 22 cm 42 x 15 mm, 22 cm 43 x 20 mm,

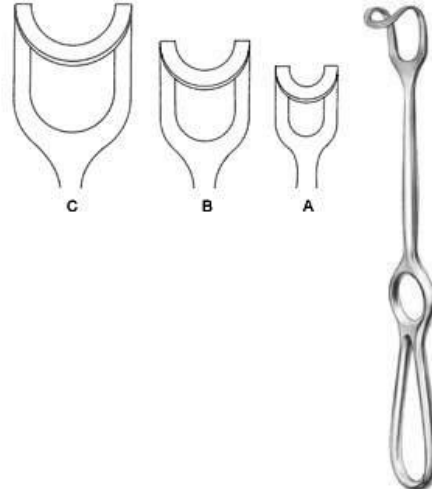

**Middeldorpf**  
**EF-5-951-01**  
**Retractor**  
 21.5 cm 18 x 17 mm, 23 cm 25 x 22 mm, 24.5 cm 30 x 31 mm,

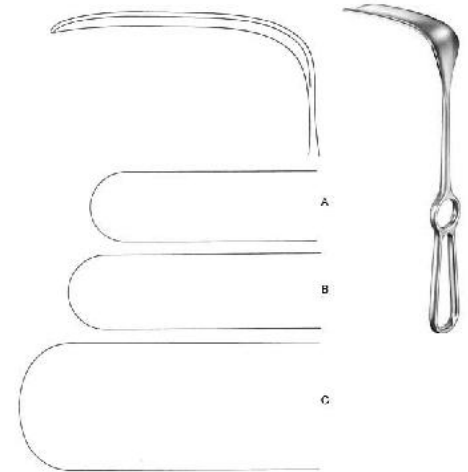

**Doyen-Stiller**  
**EF-5-952-01**  
**Retractor**  
 26 cm 97 x 29 mm, 26 cm 101 x 31 mm, 26 cm 127 x 52 mm,



**Hosel**  
**EF-5-953-01**  
**Retractor**  
 26 cm 63 x 21 mm, 26 cm 83 x 30 mm, 26 cm 103 x 30 mm, 26 cm 120 x 30 mm, 26 cm 140 x 30 mm, 26 cm 140 x 40 mm,

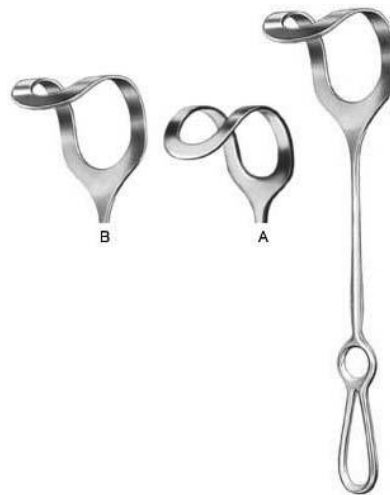

**Middeldorpf**  
**EF-5-954-01**  
**Retractor**  
 27 cm 48 x 45 mm, 27 cm 52 x 50 mm, 27 cm 60 x 70 mm,

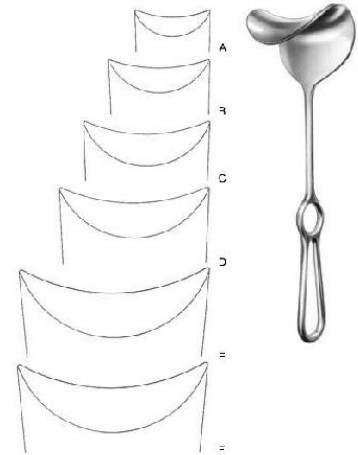

**Fritsch**  
**EF-5-955-00**  
**Retractor**  
 23.5 cm 37 x 31 mm, 24 cm 38 x 40 mm, 25 cm 43 x 51 mm, 25 cm 49 x 61 mm, 25.5 cm 48 x 75 mm, 25.5 cm 65 x 85 mm,

# Retractors



EF-5-956-22  
Retractor  
24 cm 48 x 88 mm,



Kocher  
EF-5-957-22  
Retractor  
24 cm 73 x 25 mm,



Kocher  
EF-5-958-01  
Retractor  
25 cm 80 x 45 mm, 25 cm 80 x 55 mm, 25 cm  
80 x 65 mm,



EF-5-959-01  
Retractor  
26 cm 110 x 27 mm,

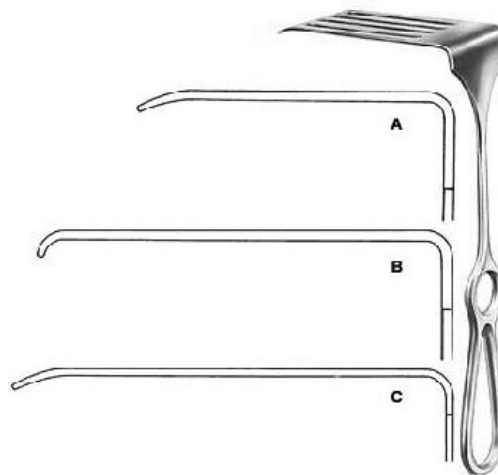

Coryllos  
EF-5-960-01  
Retractor  
24 cm 85 x 22 mm, 24 cm 108 x 43 mm, 24 cm  
119 x 65 mm,



Davidson  
EF-5-961-01  
Retractor  
19 cm 80 x 54 mm, 18.5 cm 80 x 95 mm,



# Retractors

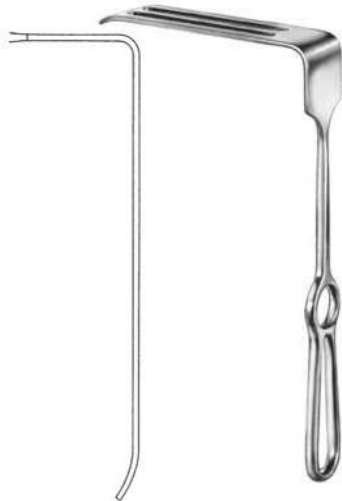

Sauerbruch  
EF-5-962-25  
Retractor  
25.5 cm 127 x 38 mm,

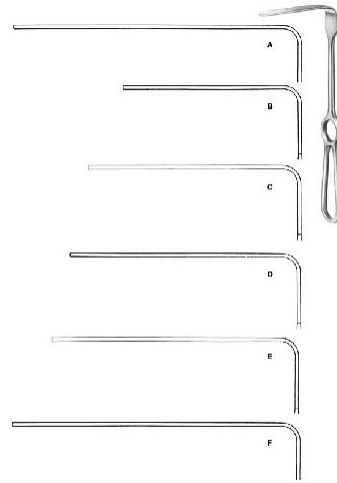

Brunner  
EF-5-963-08  
Retractor  
25.5 cm 84 x 20 mm, 25.5 cm 104 x 25 mm, 25.5 cm 124 x 30 mm, 25.5 cm 130 x 30 mm, 25.5 cm 144 x 30 mm, 25.5 cm 160 x 30 mm, 25.5 cm 164 x 30 mm,

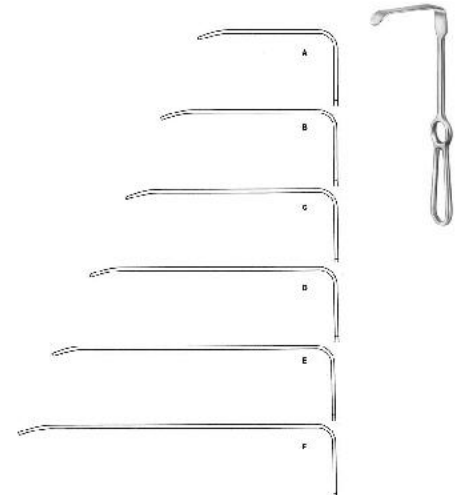

Brunner  
EF-5-964-08  
Retractor  
25.5 cm 82 x 20 mm, 25.5 cm 102 x 20 mm, 25.5 cm 122 x 25 mm, 25.5 cm 140 x 25 mm, 25.5 cm 162 x 30 mm, 25.5 cm 182 x 30 mm,

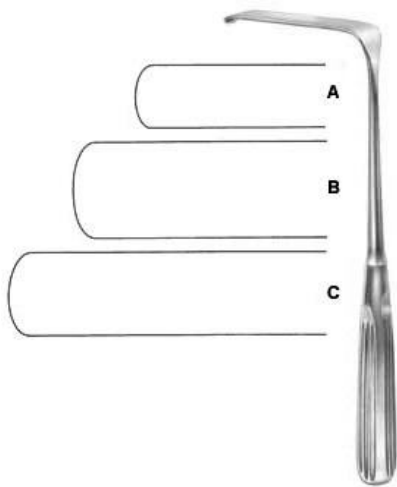

Sauerbruch  
EF-5-965-01  
Retractor  
22.5 cm 50 x 15mm, 22.5 cm 63 x 23mm, 22.5 cm 80 x 20mm,



Deaver  
EF-5-966-01  
Retractor  
18 cm 19mm,

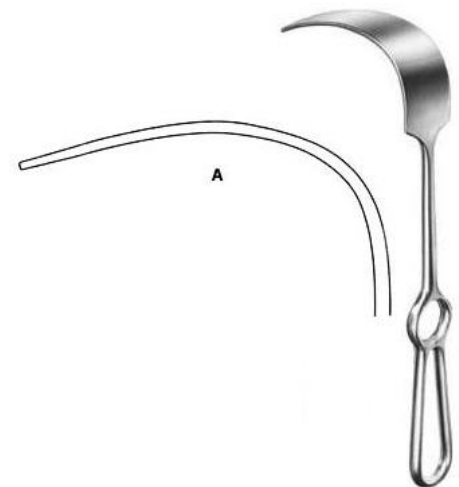

Mikulicz  
EF-5-968-01  
Retractor  
25 cm 90 x 35mm, 25 cm 125 x 50mm, 25 cm 160 x 50mm,

# Retractors



**Mikulicz**  
**EF-5-969-26**  
**Retractor**  
 26 cm 90 x 55mm,

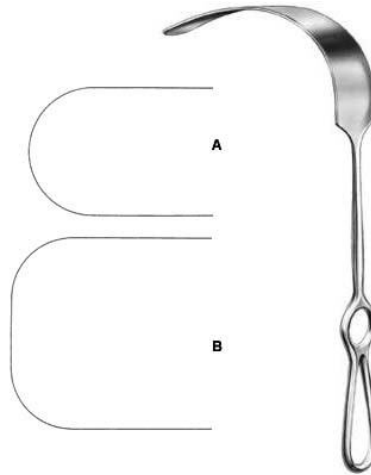

**Kelly**  
**EF-5-970-01**  
**Retractor**  
 27.5 cm 205 x 38mm, 27.5 cm 205 x 57mm,



**Farabeuf**  
**EF-5-971-00**  
**Retractor**  
 15 cm Fig. 1 = 23 x 16, 15 cm Fig. 1 = 26 x 16, 15 cm Fig. 2 = 27 x 16, 15 cm Fig. 2 = 30 x 16,

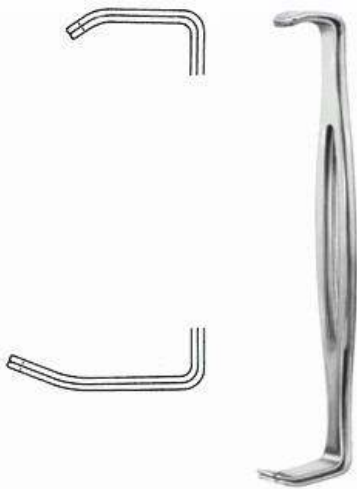

**Parker-Langenbeck**  
**EF-5-972-00**  
**Retractor**  
 21.5 cm Fig. 1 = 21x15mm, 21.5 cm Fig. 1 = 40x15mm, 21.5 cm Fig. 2 = 25x15mm, 21.5 cm Fig. 2 = 45x15mm,



**Alm**  
**EF-5-973-07**  
**Wound Spreaders, self-retaining**  
 7 cm,



**Alm**  
**EF-5-974-07**  
**Wound Spreaders, self-retaining**  
 7 cm,

# Retractors



Gosset  
EF-5-975-22  
Abdominal Retractor  
18.5 cm,



Balfour-Baby  
EF-5-976-00  
Abdominal Retractor spreading 90mm, 1  
central blade 24 x 20mm  
12.5 cm,

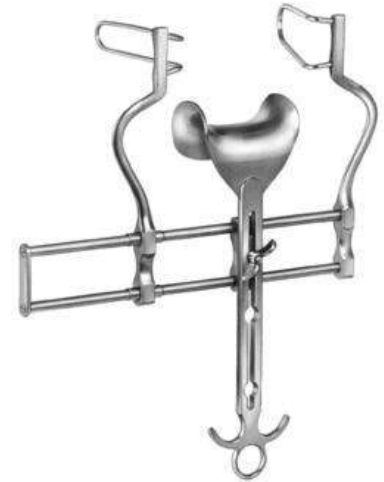

Balfour  
EF-5-977-00  
Abdominal Retractor spreading 180mm,  
lateral blades 70 x 35mm, 1 central blade  
20 cm,



Deaver  
EF-5-967-04  
Retractor  
31.5 cm 25mm, 31.5 cm 38mm, 31.5 cm  
50mm, 31.5 cm 100mm,

# Probes



EF-5-1001-11  
Probe

11.5 cm, 13 cm, 14.5 cm, 16 cm, 18 cm, 20 cm, 25 cm, 30 cm,



EF-5-1002-11  
Probe

11.5 cm, 13 cm, 14.5 cm, 16 cm, 18 cm, 20 cm, 25 cm, 30 cm,

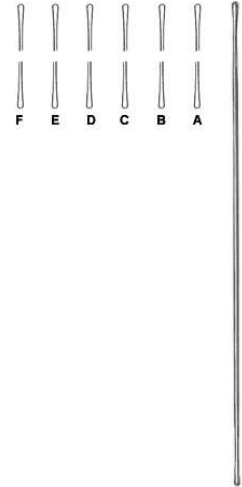

EF-5-1003-13  
Probe

13 cm, 14.5 cm, 16 cm, 18 cm, 20 cm, 25 cm,



EF-5-1004-13  
Probe with eye

13 cm, 14.5 cm, 16 cm,

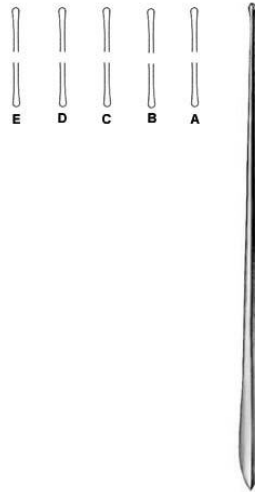

EF-5-1006-13  
Myrtle Leaf Probe

13 cm, 14.5 cm, 16 cm, 18 cm, 20 cm,



EF-5-1007-13  
Grooved Director

13 cm, 14 cm, 16 cm,

# Probes



EF-5-1008-13  
Grooved Director  
13 cm, 14.5 cm, 16 cm,



Doyen  
EF-5-1009-14  
Grooved Director  
14.5 cm,



Nelaton  
EF-5-1010-16  
Grooved Director  
16 cm,

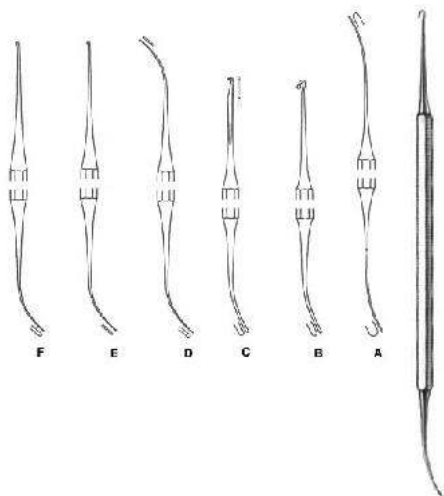

Varady  
EF-5-1011-01  
Phlebodissector  
18 cm, 17.5 cm,

# Plaster

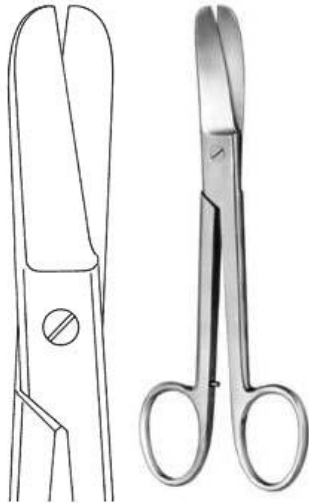

Lorenz  
EF-6-101-23  
Bandage Scissors heavy pattern  
23 cm,



Lister  
EF-6-102-14  
Bandage Scissors  
14.5 cm, 18.5 cm, 20 cm,



Bergmann  
EF-6-103-23  
Plaster Shears  
23.5 cm,



Esmarch  
EF-6-104-20  
Plaster Shears heavy pattern, short blades  
20 cm,



EF-6-105-15  
Bandage Scissors black plastic ring with  
autodavable  
16 cm, 19 cm,



EF-6-106-18  
Bandage Scissors black plastic rings  
19 cm, 16 cm,

# Probes

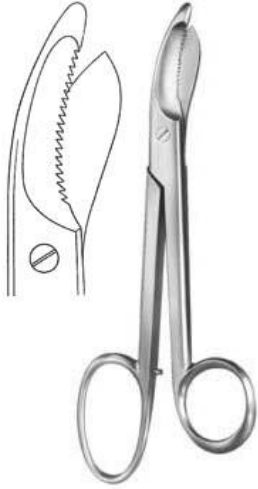

**Bruns**  
EF-6-107-24  
Plaster Scissors  
24 cm,

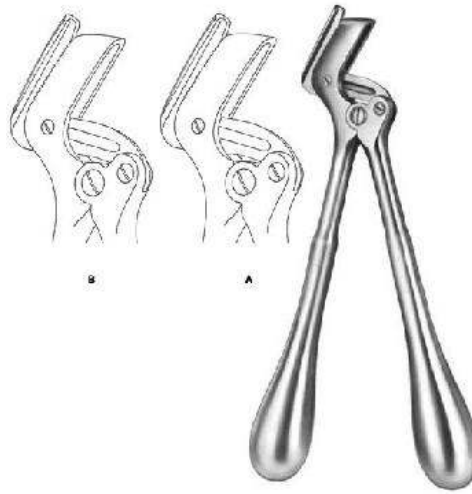

**Stille-Martin**  
EF-6-108-23  
Plaster Shears  
23 cm, 27 cm, 38 cm,

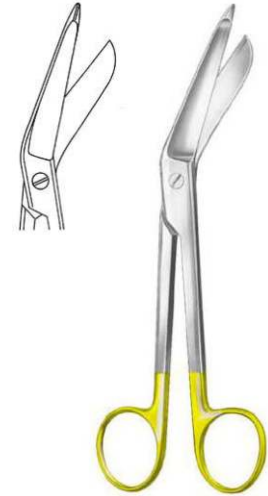

**Lister**  
EF-6-109-18  
Bandage Scissors  
18 cm,



**Bruns**  
EF-6-110-24  
Plaster Scissors  
24 cm,



**Hopkins**  
EF-6-111-20  
Plaster Knife with wooden handle  
20 cm,



**Reiner**  
EF-6-112-18  
Plaster Knife  
18 cm,

# Probes



**Reiner**  
EF-6-113-18  
Plaster Knife  
18 cm,



**Martin**  
EF-6-114-21  
Plaster Knife with wooden handle  
21 cm,



**Engel**  
EF-6-115-14  
Plaster Saw  
15.5 cm,

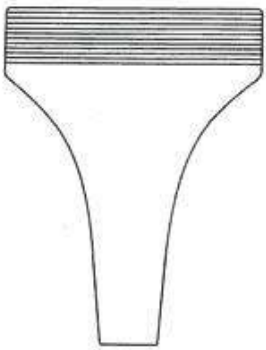

**Hennig**  
EF-6-116-28  
Plaster Spreader  
28 cm,



**Wolff**  
EF-6-117-18  
Plaster Breaker  
18 cm, 26.5 cm,



## Neurosurgery



Gigli  
EF-8-101-01  
Wire Saw Handle



De Martel  
EF-8-102-33  
Wire Saw Guide  
33 cm,



Crutchfield  
EF-8-103-01  
Skull Traction Tong small pattern



EF-8-104-01  
Skull Traction Tong large pattern  
22.5 cm,



Dahlgren  
EF-8-105-20  
Cranial Rongeur  
20 cm,



Olivecrona-Toennis  
EF-8-106-14  
Clip Applying Forceps

# Neurosurgery



McKenzie  
EF-8-107-19  
Clip Applying Forceps  
18.5 cm,



Olivecrona  
EF-8-108-18  
Dura Dissector  
18 cm,



Olivecrona  
EF-8-109-19  
Dura Dissector  
20 cm,



Milligan  
EF-8-110-21  
Dura Dissector  
21.5 cm,



Davis  
EF-8-111-21  
Dura Dissector sharp  
21.5 cm,



EF-8-112-22  
Dura Dissector  
22 cm,

# Neurosurgery



Davis  
EF-8-113-24  
Dura Dissector  
24.5 cm,



Love  
EF-8-114-19  
Nerve Root Retractor  
21.5 cm, 18 cm, 11 cm,



Olivecrona  
EF-8-115-18  
Brain Spatula  
18 cm,



Scoville  
EF-8-116-23  
Nerve Root Retractor 8mm  
23.5 cm,



Holsher  
EF-8-117-24  
Nerve Root Retractor 8mm  
23.5 cm,



Scoville  
EF-8-118-19  
Nerve Root Retractor 7mm  
16.5 cm,

# Neurosurgery



Groningen  
EF-8-119-26  
Nerve Hook  
26.5 cm,



Groningen  
EF-8-120-26  
Nerve Hook  
26.5 cm,



Cushing  
EF-8-121-19  
Nerve Hook blunt  
19 cm,28 cm,

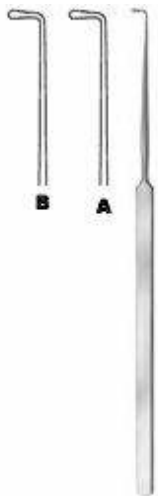

Cushing  
EF-8-122-19  
Nerve Hook  
19.5 cm,28 cm,



Smithwick  
EF-8-123-17  
Nerve Hook  
17 cm,21 cm,



Halle  
EF-8-125-20  
Dura Knife  
20 cm,

# Neurosurgery



Adson  
EF-8-126-20  
Dura Hook  
20 cm,



Graham  
EF-8-127-16  
Dura Hook blunt  
16.5 cm,



Sachs  
EF-8-128-18  
Dura Hook sharp  
18 cm,



Toennis  
EF-8-129-15  
Dura Hook sharp  
14.5 cm,



Frazier  
EF-8-130-13  
Dura Hook sharp  
13 cm, 18 cm,



Krayenbuhl  
EF-8-131-01  
Nerve and Vessel Hooklet  
18.5 cm Fig. 1, 18.5 cm Fig. 2,

# Neurosurgery



Cloward  
EF-8-132-16  
Lamina Spreader  
16 cm,

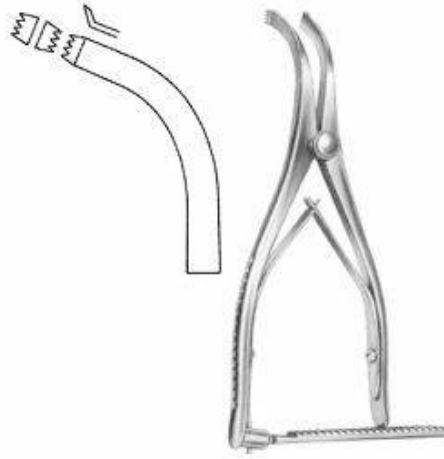

Inge  
EF-8-133-17  
Lamina Spreader  
16 cm,

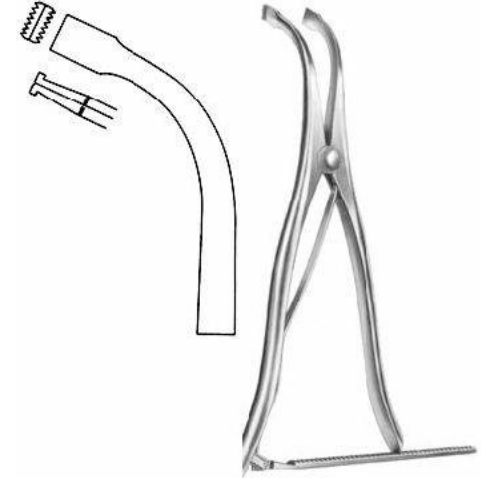

Inge  
EF-8-134-27  
Lamina Spreader  
25.5 cm,

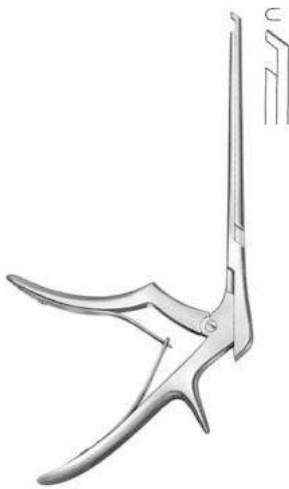

Ferris-Smith Kerrison  
EF-8-135-03  
Laminectomy Punch 3mm downwards cutting  
40 degree shaft length 180 mm

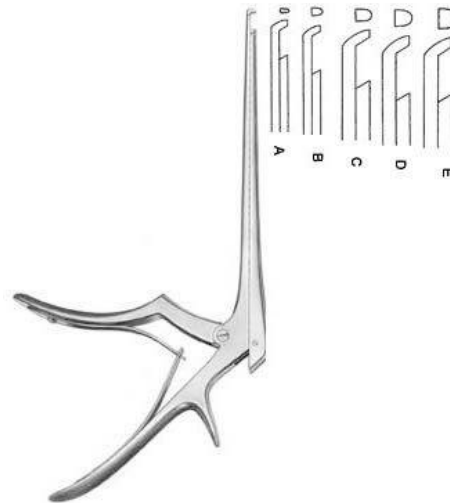

Ferris-Smith Kerrison  
EF-8-138-01  
Laminectomy Punch upwards cutting shaft  
length 180 mm  
1 mm, 2 mm, 3 mm, 4 mm, 5 mm, 6 mm,

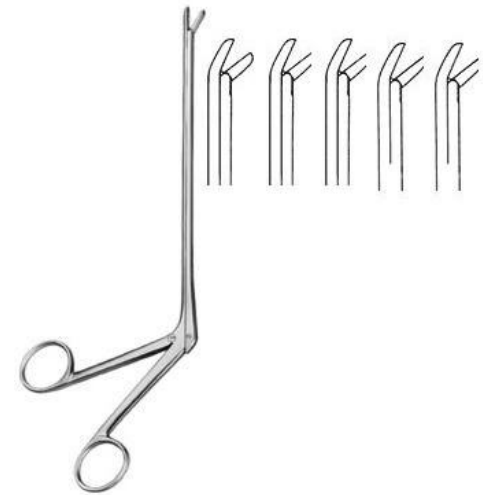

Cushing  
EF-8-139-01  
Laminectomy Rongeur jaw 2 x 10 to 4 x 10  
mm straight shaft length 180 mm

# Neurosurgery

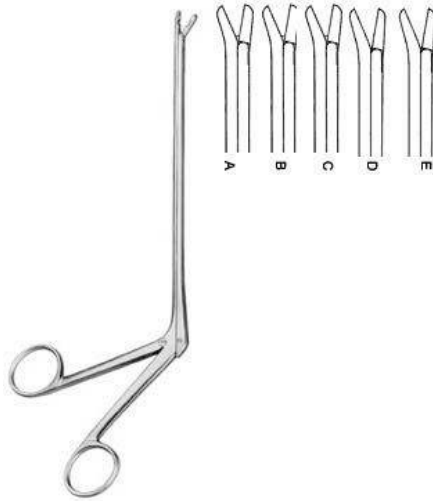

**Cushing**  
EF-8-140-01

Laminectomy Rongeur jaw 2 x 10 to 4 x 10 mm upwards 45 degree shaft length 120 mm



**Ferris-Smith Kerrison**  
EF-8-137-01

Laminectomy Punch  
1 mm, 2 mm, 3 mm, 4 mm, 5 mm, 6 mm,

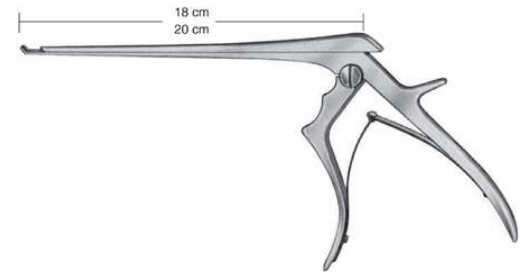

**FERRIS-SMITH-KERRISON**  
EF-9-137-01  
with thin footplate

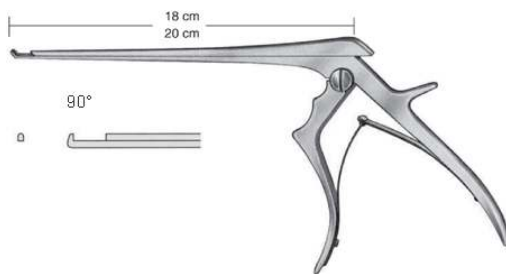

**FERRIS-SMITH-KERRISON**  
EF-9-137-02

With thin footplate  
18 cm , 20 cm , 1mm ,2 mm ,3 mm ,4 mm ,5 mm,

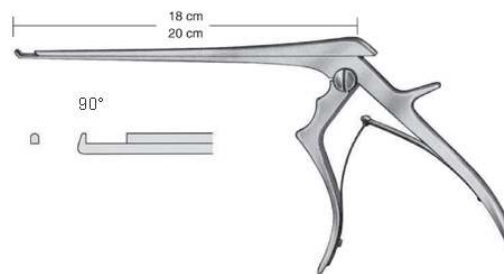

**FERRIS-SMITH-KERRISON**  
EF-9-137-03

With thin footplate  
18 cm , 20 cm , 1mm ,2 mm ,3 mm ,4 mm ,5 mm,

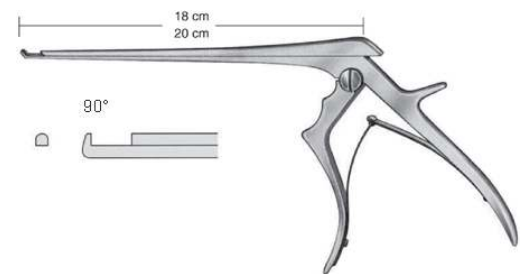

**FERRIS-SMITH-KERRISON**  
EF-9-137-04

With thin footplate  
18 cm , 20 cm , 1mm ,2 mm ,3 mm ,4 mm ,5 mm,

# Neurosurgery

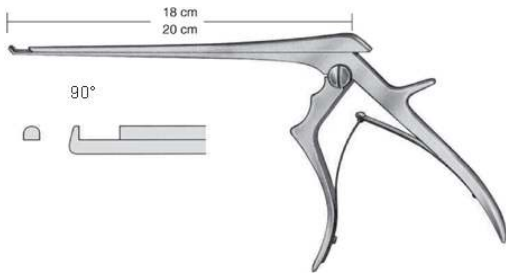

**FERRIS-SMITH-KERRISON**  
EF-9-137-05

With thin footplate  
18 cm , 20 cm , 1mm ,2 mm,3 mm ,4 mm ,5 mm,

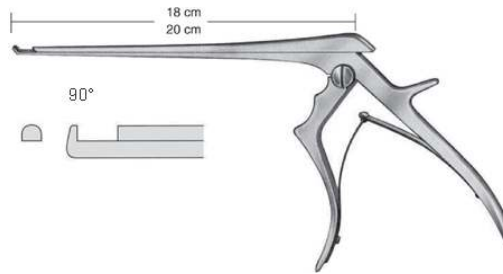

**FERRIS-SMITH-KERRISON**  
EF-9-137-06

With thin footplate  
18 cm , 20 cm , 1mm ,2 mm,3 mm ,4 mm ,5 mm,

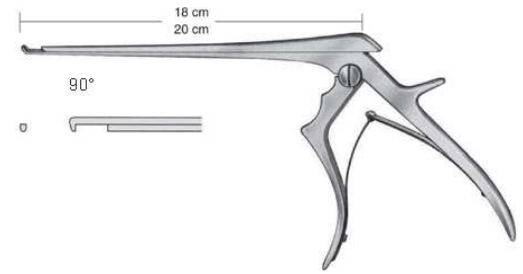

**FERRIS-SMITH-KERRISON**  
EF-9-137-07

with thin footplate  
18 cm , 20 cm , 1 mm,2 mm,3 mm,4 mm,5 mm,

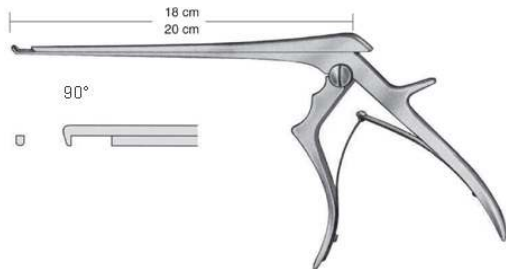

**FERRIS-SMITH-KERRISON**  
EF-9-137-08

with thin footplate  
18 cm , 20 cm , 1 mm,2 mm,3 mm,4 mm,5 mm,

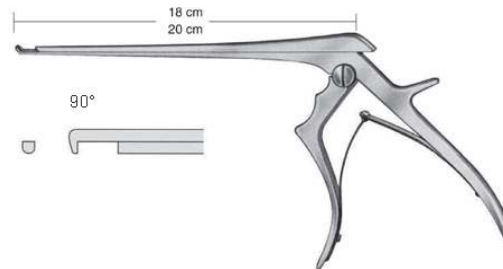

**FERRIS-SMITH-KERRISON**  
EF-9-137-09

with thin footplate  
18 cm , 20 cm , 1 mm,2 mm,3 mm,4 mm,5 mm,

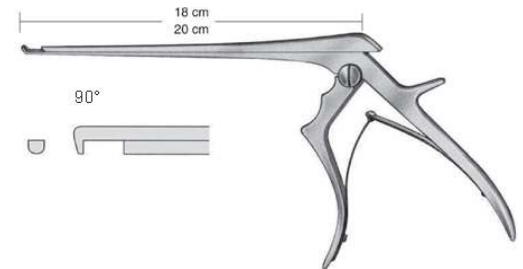

**FERRIS-SMITH-KERRISON**  
EF-9-137-10

with thin footplate  
18 cm , 20 cm , 1 mm,2 mm,3 mm,4 mm,5 mm,



# Neurosurgery

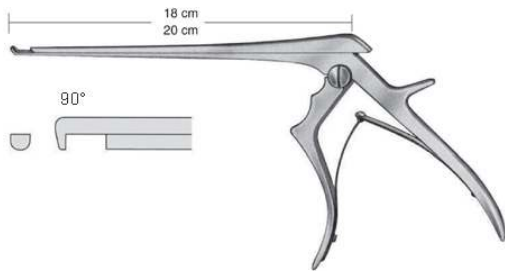

**FERRIS-SMITH-KERRISON**  
**EF-9-137-11**  
 with thin footplate  
 18 cm , 20 cm , 1 mm,2 mm,3 mm,4 mm,5 mm,

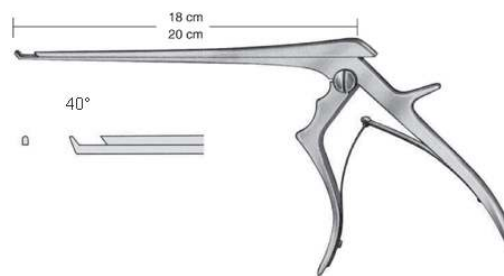

**FERRIS-SMITH-KERRISON**  
**EF-9-137-12**  
 with thin footplate  
 1 mm,2 mm,3 mm,4 mm,5 mm,

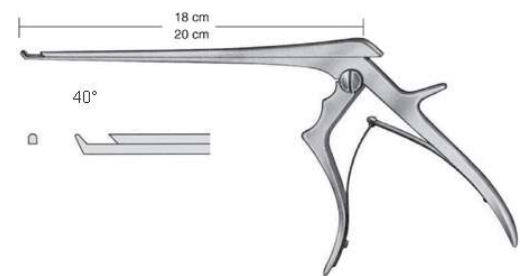

**FERRIS-SMITH-KERRISON**  
**EF-9-137-13**  
 with thin footplate  
 1 mm,2 mm,3 mm,4 mm,5 mm,

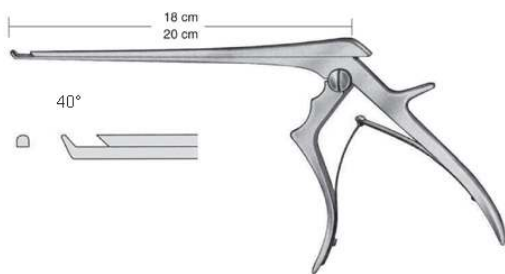

**FERRIS-SMITH-KERRISON**  
**EF-9-137-14**  
 with thin footplate  
 1 mm,2 mm,3 mm,4 mm,5 mm,

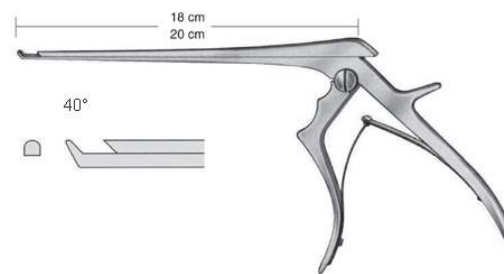

**FERRIS-SMITH-KERRISON**  
**EF-9-137-15**  
 with thin footplate  
 1 mm,2 mm,3 mm,4 mm,5 mm,

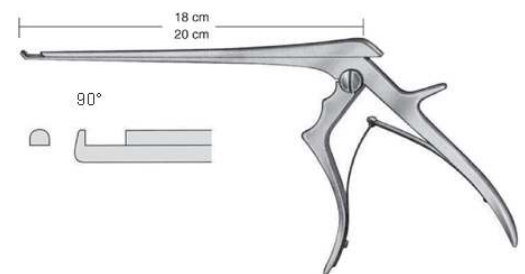

**FERRIS-SMITH-KERRISON**  
**EF-9-137-16**  
 with thin footplate  
 1 mm,2 mm,3 mm,4 mm,5 mm,

# Neurosurgery

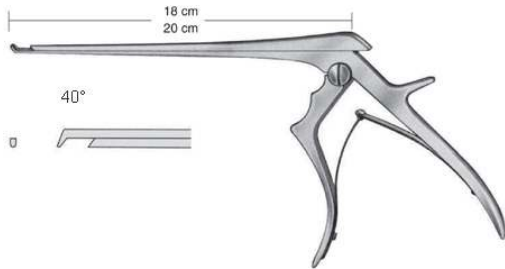

**FERRIS-SMITH-KERRISON**  
**EF-9-137-17**  
 with thin footplate  
 1 mm,2 mm,3 mm,4 mm,5 mm,

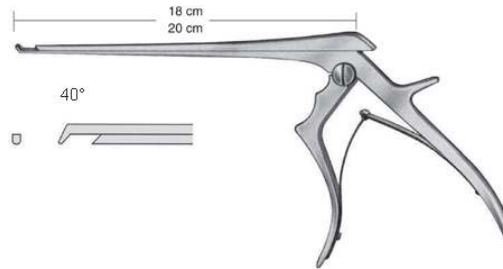

**FERRIS-SMITH-KERRISON**  
**EF-9-137-18**  
 with thin footplate  
 1 mm,2 mm,3 mm,4 mm,5 mm,

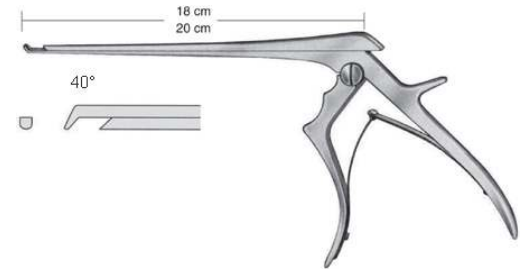

**FERRIS-SMITH-KERRISON**  
**EF-9-137-19**  
 with thin footplate  
 1 mm,2 mm,3 mm,4 mm,5 mm,

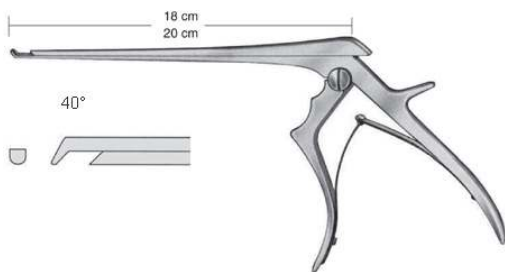

**FERRIS-SMITH-KERRISON**  
**EF-9-137-20**  
 with thin footplate  
 1 mm,2 mm,3 mm,4 mm,5 mm,

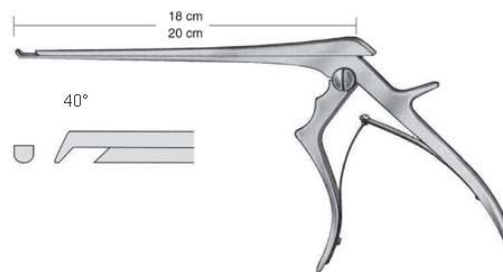

**FERRIS-SMITH-KERRISON**  
**EF-9-137-21**  
 with thin footplate  
 1 mm,2 mm,3 mm,4 mm,5 mm,

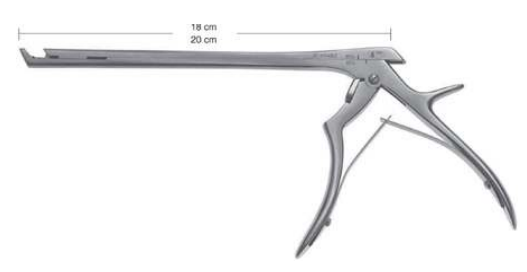

**EF-9-137-22**  
 18 cm,20 cm ,

# Neurosurgery

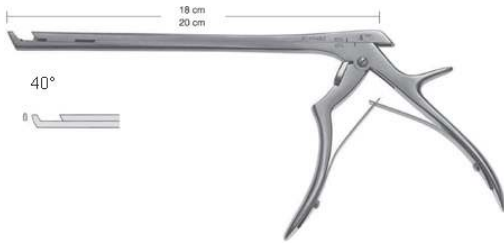

**EF-9-137-23**

18 cm , 20 cm , 1mm,2 mm,3 mm,4 mm,5 mm,6 mm,

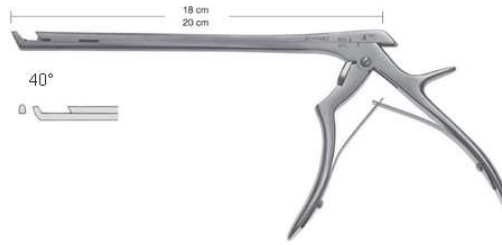

**EF-9-137-24**

18 cm , 20 cm , 1mm,2 mm,3 mm,4 mm,5 mm,6 mm,



**EF-9-137-25**

18 cm , 20 cm , 1mm,2 mm,3 mm,4 mm,5 mm,6 mm,



**EF-9-137-26**

18 cm , 20 cm , 1mm,2 mm,3 mm,4 mm,5 mm,6 mm,



**EF-9-137-27**

18 cm , 20 cm , 1mm,2 mm,3 mm,4 mm,5 mm,6 mm,



**EF-9-137-28**

18 cm , 20 cm , 1mm,2 mm,3 mm,4 mm,5 mm,6 mm,

# Neurosurgery

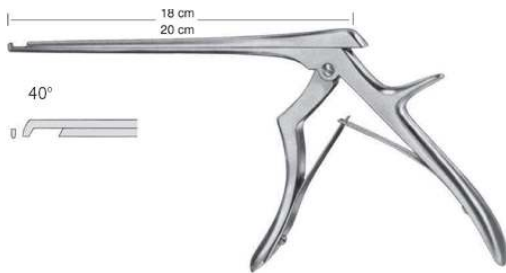

EF-9-137-29

18 cm , 20 cm , 1mm,2 mm,3 mm,4 mm,5 mm,6 mm,

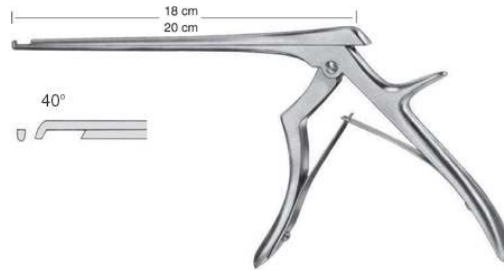

EF-9-137-30

18 cm , 20 cm , 1mm,2 mm,3 mm,4 mm,5 mm,6 mm,

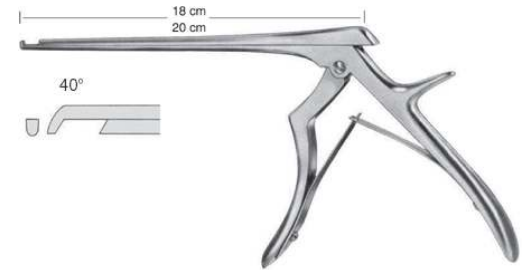

EF-9-137-31

18 cm , 20 cm , 1mm,2 mm,3 mm,4 mm,5 mm,6 mm,

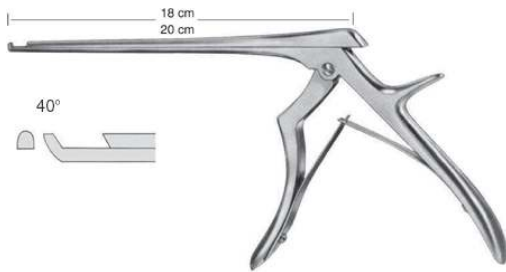

EF-9-137-32

18 cm , 20 cm , 1mm,2 mm,3 mm,4 mm,5 mm,6 mm,

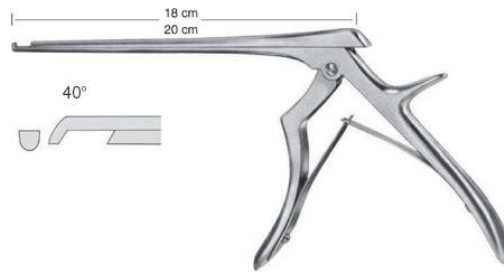

EF-9-137-33

18 cm , 20 cm , 1mm,2 mm,3 mm,4 mm,5 mm,6 mm,

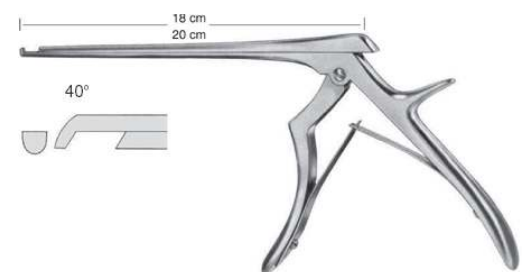

EF-9-137-34

18 cm , 20 cm , 1mm,2 mm,3 mm,4 mm,5 mm,6 mm,

# Neurosurgery



detachable  
EF-9-137-35  
detachable

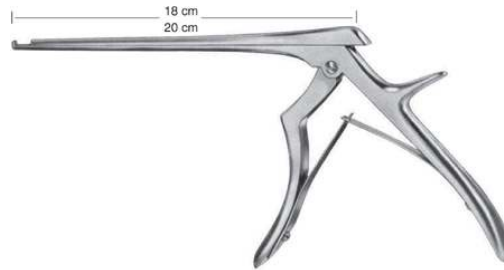

FERRIS-SMITH-KERRISON  
EF-9-137-36  
FERRIS-SMITH-KERRISON

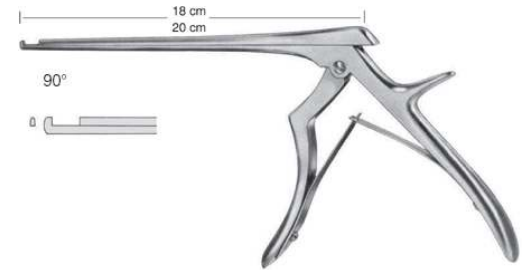

FERRIS-SMITH-KERRISON  
EF-9-137-37  
FERRIS-SMITH-KERRISON  
18 cm , 20 cm ,  
1mm,2mm,3mm,4mm,5mm,6mm,

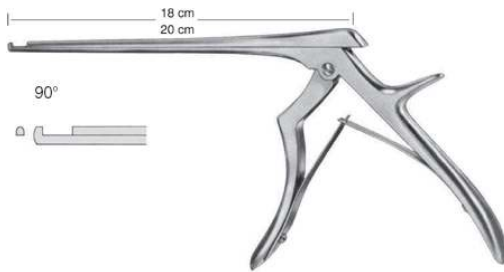

FERRIS-SMITH-KERRISON  
EF-9-137-38  
FERRIS-SMITH-KERRISON  
18 cm , 20 cm , 1mm,18 cm , 20 cm ,  
2mm,18 cm , 20 cm , 3mm,18 cm , 20 cm ,  
4mm,18 cm , 20 cm , 5mm,18 cm , 20 cm ,  
6mm,

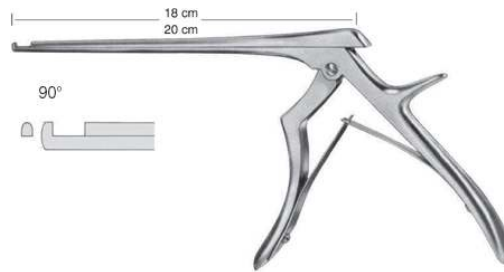

FERRIS-SMITH-KERRISON  
EF-9-137-39  
FERRIS-SMITH-KERRISON  
18 cm , 20 cm , 1mm,18 cm , 20 cm ,  
2mm,18 cm , 20 cm , 3mm,18 cm , 20 cm ,  
4mm,18 cm , 20 cm , 5mm,18 cm , 20 cm ,  
6mm,

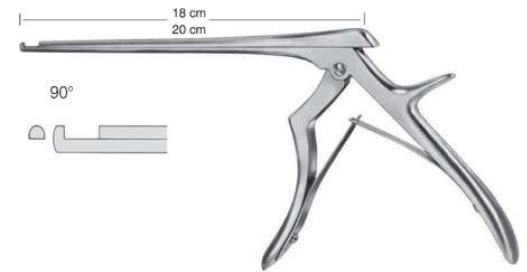

FERRIS-SMITH-KERRISON  
EF-9-137-40  
FERRIS-SMITH-KERRISON  
18 cm , 20 cm , 1mm,18 cm , 20 cm ,  
2mm,18 cm , 20 cm , 3mm,18 cm , 20 cm ,  
4mm,18 cm , 20 cm , 5mm,18 cm , 20 cm ,  
6mm,

# Neurosurgery

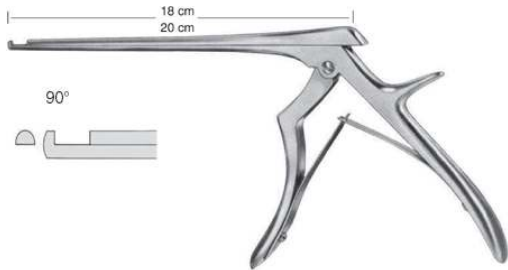

**FERRIS-SMITH-KERRISON**

**EF-9-137-41**

**FERRIS-SMITH-KERRISON**

18 cm , 20 cm , 1mm,18 cm , 20 cm ,  
2mm,18 cm , 20 cm , 3mm,18 cm , 20 cm ,  
4mm,18 cm , 20 cm , 5mm,18 cm , 20 cm ,  
6mm,

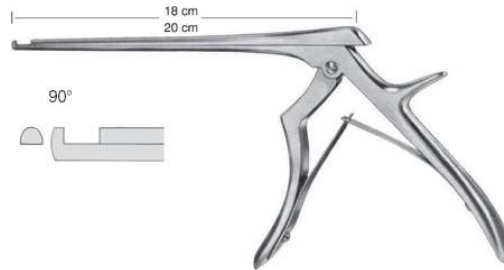

**FERRIS-SMITH-KERRISON**

**EF-9-137-42**

**FERRIS-SMITH-KERRISON**

18 cm , 20 cm , 1mm,18 cm , 20 cm ,  
2mm,18 cm , 20 cm , 3mm,18 cm , 20 cm ,  
4mm,18 cm , 20 cm , 5mm,18 cm , 20 cm ,  
6mm,

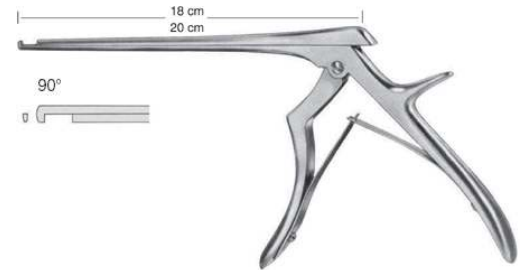

**FERRIS-SMITH-KERRISON**

**EF-9-137-43**

**FERRIS-SMITH-KERRISON**

18 cm , 20 cm , 1mm,18 cm , 20 cm ,  
2mm,18 cm , 20 cm , 3mm,18 cm , 20 cm ,  
4mm,18 cm , 20 cm , 5mm,18 cm , 20 cm ,  
6mm,

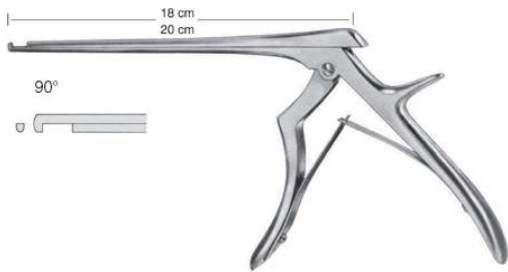

**FERRIS-SMITH-KERRISON**

**EF-9-137-44**

**FERRIS-SMITH-KERRISON**

18 cm , 20 cm , 1mm,18 cm , 20 cm ,  
2mm,18 cm , 20 cm , 3mm,18 cm , 20 cm ,  
4mm,18 cm , 20 cm , 5mm,18 cm , 20 cm ,  
6mm,

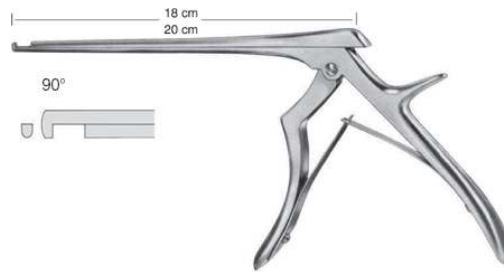

**FERRIS-SMITH-KERRISON**

**EF-9-137-45**

**FERRIS-SMITH-KERRISON**

18 cm , 20 cm , 1mm,18 cm , 20 cm ,  
2mm,18 cm , 20 cm , 3mm,18 cm , 20 cm ,  
4mm,18 cm , 20 cm , 5mm,18 cm , 20 cm ,  
6mm,

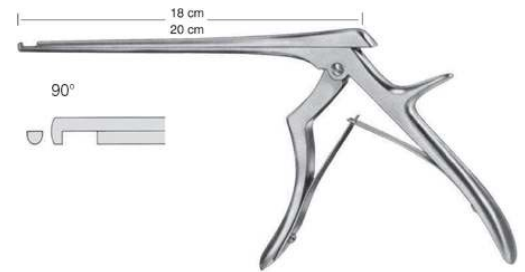

**FERRIS-SMITH-KERRISON**

**EF-9-137-46**

**FERRIS-SMITH-KERRISON**

18 cm , 20 cm , 1mm,18 cm , 20 cm ,  
2mm,18 cm , 20 cm , 3mm,18 cm , 20 cm ,  
4mm,18 cm , 20 cm , 5mm,18 cm , 20 cm ,  
6mm,

# Neurosurgery

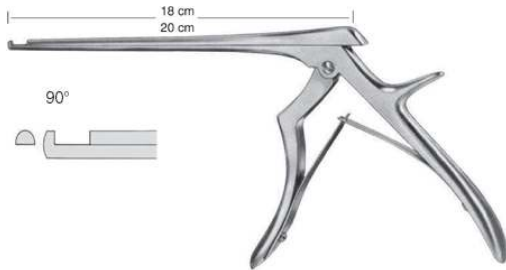

**FERRIS-SMITH-KERRISON**  
EF-9-137-41

**FERRIS-SMITH-KERRISON**  
18 cm , 20 cm , 1mm,18 cm , 20 cm ,  
2mm,18 cm , 20 cm , 3mm,18 cm , 20 cm ,  
4mm,18 cm , 20 cm , 5mm,18 cm , 20 cm ,  
6mm,

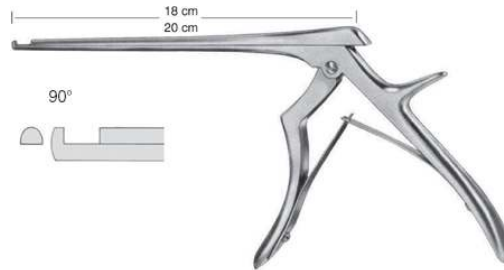

**FERRIS-SMITH-KERRISON**  
EF-9-137-42

**FERRIS-SMITH-KERRISON**  
18 cm , 20 cm , 1mm,18 cm , 20 cm ,  
2mm,18 cm , 20 cm , 3mm,18 cm , 20 cm ,  
4mm,18 cm , 20 cm , 5mm,18 cm , 20 cm ,  
6mm,

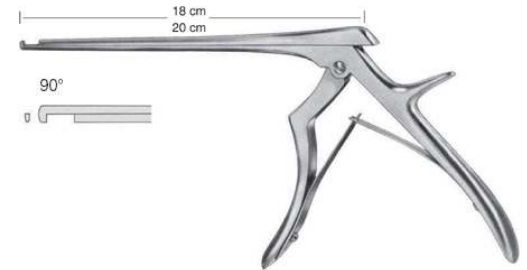

**FERRIS-SMITH-KERRISON**  
EF-9-137-43

**FERRIS-SMITH-KERRISON**  
18 cm , 20 cm , 1mm,18 cm , 20 cm ,  
2mm,18 cm , 20 cm , 3mm,18 cm , 20 cm ,  
4mm,18 cm , 20 cm , 5mm,18 cm , 20 cm ,  
6mm,

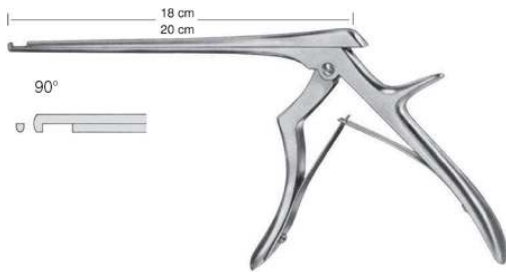

**FERRIS-SMITH-KERRISON**  
EF-9-137-44

**FERRIS-SMITH-KERRISON**  
18 cm , 20 cm , 1mm,18 cm , 20 cm ,  
2mm,18 cm , 20 cm , 3mm,18 cm , 20 cm ,  
4mm,18 cm , 20 cm , 5mm,18 cm , 20 cm ,  
6mm,

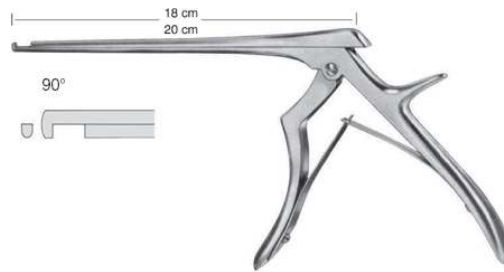

**FERRIS-SMITH-KERRISON**  
EF-9-137-45

**FERRIS-SMITH-KERRISON**  
18 cm , 20 cm , 1mm,18 cm , 20 cm ,  
2mm,18 cm , 20 cm , 3mm,18 cm , 20 cm ,  
4mm,18 cm , 20 cm , 5mm,18 cm , 20 cm ,  
6mm,

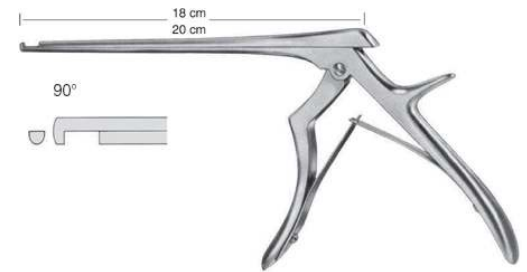

**FERRIS-SMITH-KERRISON**  
EF-9-137-46

**FERRIS-SMITH-KERRISON**  
18 cm , 20 cm , 1mm,18 cm , 20 cm ,  
2mm,18 cm , 20 cm , 3mm,18 cm , 20 cm ,  
4mm,18 cm , 20 cm , 5mm,18 cm , 20 cm ,  
6mm,

# Neurosurgery

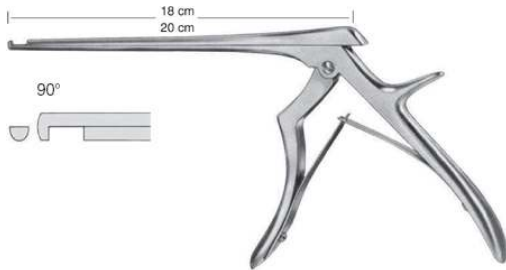

**FERRIS-SMITH-KERRISON**  
EF-9-137-47

**FERRIS-SMITH-KERRISON**  
18 cm , 20 cm , 1mm,18 cm , 20 cm ,  
2mm,18 cm , 20 cm , 3mm,18 cm , 20 cm ,  
4mm,18 cm , 20 cm , 5mm,18 cm , 20 cm ,  
6mm,

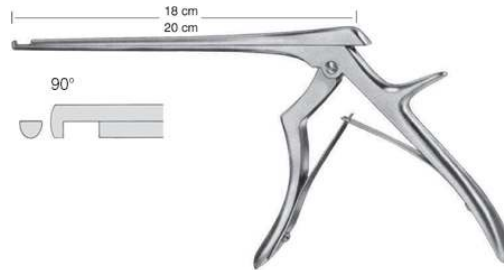

**FERRIS-SMITH-KERRISON**  
EF-9-137-48

**FERRIS-SMITH-KERRISON**  
18 cm , 20 cm , 1mm,18 cm , 20 cm ,  
2mm,18 cm , 20 cm , 3mm,18 cm , 20 cm ,  
4mm,18 cm , 20 cm , 5mm,18 cm , 20 cm ,  
6mm,

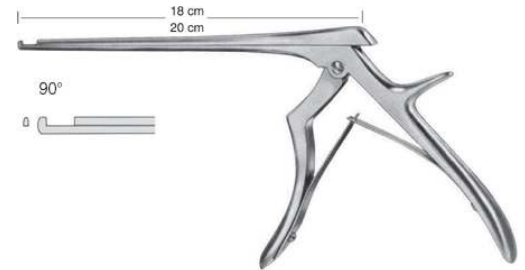

**FERRIS-SMITH-KERRISON**  
EF-9-137-49

**FERRIS-SMITH-KERRISON**  
18 cm , 20 cm , 1mm,18 cm , 20 cm ,  
2mm,18 cm , 20 cm , 3mm,18 cm , 20 cm ,  
4mm,18 cm , 20 cm , 5mm,18 cm , 20 cm ,  
6mm,

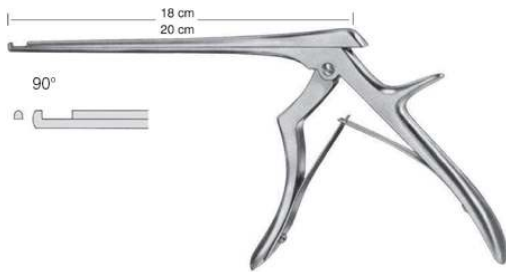

**FERRIS-SMITH-KERRISON**  
EF-9-137-50

**FERRIS-SMITH-KERRISON**  
18 cm , 20 cm , 1mm,18 cm , 20 cm ,  
2mm,18 cm , 20 cm , 3mm,18 cm , 20 cm ,  
4mm,18 cm , 20 cm , 5mm,18 cm , 20 cm ,  
6mm,

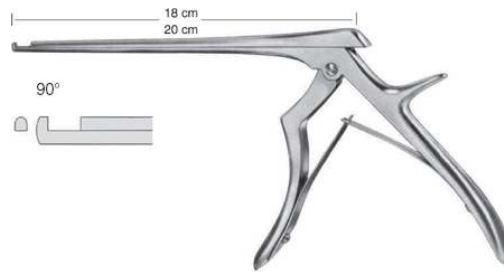

**FERRIS-SMITH-KERRISON**  
EF-9-137-51

**FERRIS-SMITH-KERRISON**  
18 cm , 20 cm , 1mm,18 cm , 20 cm ,  
2mm,18 cm , 20 cm , 3mm,18 cm , 20 cm ,  
4mm,18 cm , 20 cm , 5mm,18 cm , 20 cm ,  
6mm,

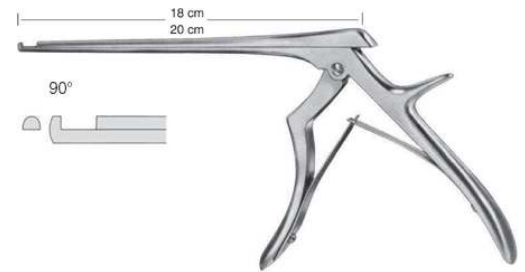

**FERRIS-SMITH-KERRISON**  
EF-9-137-52

**FERRIS-SMITH-KERRISON**  
18 cm , 20 cm , 1mm,18 cm , 20 cm ,  
2mm,18 cm , 20 cm , 3mm,18 cm , 20 cm ,  
4mm,18 cm , 20 cm , 5mm,18 cm , 20 cm ,  
6mm,



# Neurosurgery

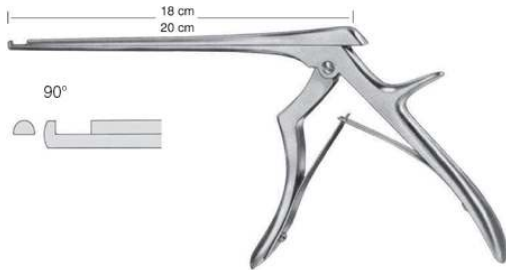

**FERRIS-SMITH-KERRISON**  
EF-9-137-53

**FERRIS-SMITH-KERRISON**  
18 cm , 20 cm , 1mm,18 cm , 20 cm ,  
2mm,18 cm , 20 cm , 3mm,18 cm , 20 cm ,  
4mm,18 cm , 20 cm , 5mm,18 cm , 20 cm ,  
6mm,

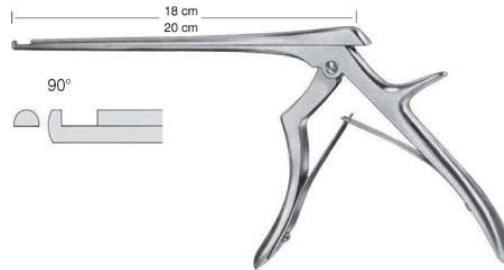

**FERRIS-SMITH-KERRISON**  
EF-9-137-54

**FERRIS-SMITH-KERRISON**  
18 cm , 20 cm , 1mm,18 cm , 20 cm ,  
2mm,18 cm , 20 cm , 3mm,18 cm , 20 cm ,  
4mm,18 cm , 20 cm , 5mm,18 cm , 20 cm ,  
6mm,

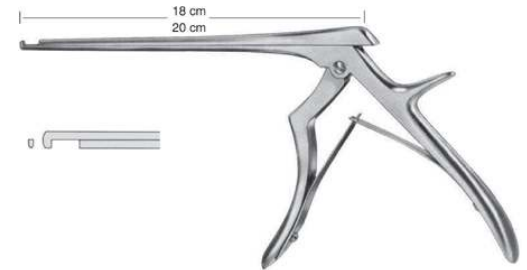

**FERRIS-SMITH-KERRISON**  
EF-9-137-55

**FERRIS-SMITH-KERRISON**  
18 cm , 20 cm , 1mm,18 cm , 20 cm ,  
2mm,18 cm , 20 cm , 3mm,18 cm , 20 cm ,  
4mm,18 cm , 20 cm , 5mm,18 cm , 20 cm ,  
6mm,

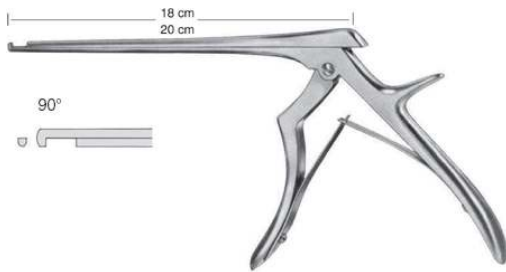

**FERRIS-SMITH-KERRISON**  
EF-9-137-56

**FERRIS-SMITH-KERRISON**  
18 cm , 20 cm , 1mm,18 cm , 20 cm ,  
2mm,18 cm , 20 cm , 3mm,18 cm , 20 cm ,  
4mm,18 cm , 20 cm , 5mm,18 cm , 20 cm ,  
6mm,

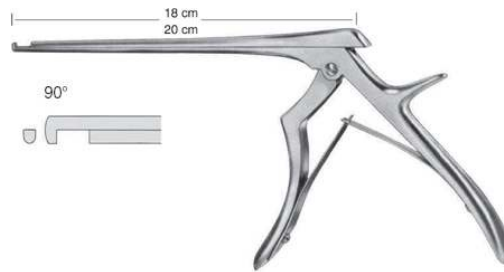

**FERRIS-SMITH-KERRISON**  
EF-9-137-57

**FERRIS-SMITH-KERRISON**  
18 cm , 20 cm , 1mm,18 cm , 20 cm ,  
2mm,18 cm , 20 cm , 3mm,18 cm , 20 cm ,  
4mm,18 cm , 20 cm , 5mm,18 cm , 20 cm ,  
6mm,

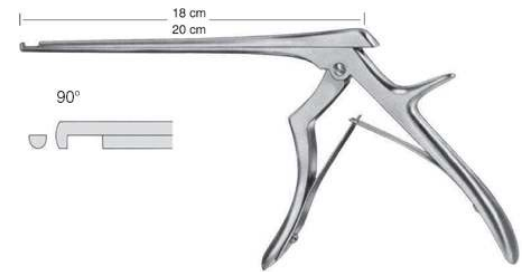

**FERRIS-SMITH-KERRISON**  
EF-9-137-58

**FERRIS-SMITH-KERRISON**  
18 cm , 20 cm , 1mm,18 cm , 20 cm ,  
2mm,18 cm , 20 cm , 3mm,18 cm , 20 cm ,  
4mm,18 cm , 20 cm , 5mm,18 cm , 20 cm ,  
6mm,

# Neurosurgery

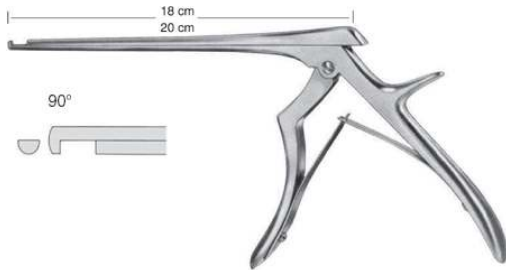

**FERRIS-SMITH-KERRISON**

**EF-9-137-59**

**FERRIS-SMITH-KERRISON**

18 cm , 20 cm , 1mm,18 cm , 20 cm ,  
2mm,18 cm , 20 cm , 3mm,18 cm , 20 cm ,  
4mm,18 cm , 20 cm , 5mm,18 cm , 20 cm ,  
6mm,

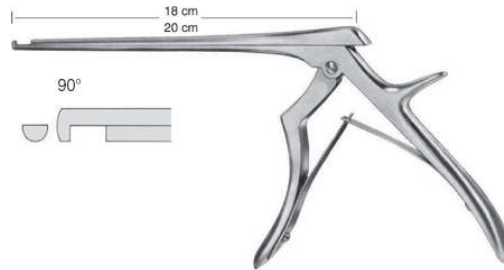

**FERRIS-SMITH-KERRISON**

**EF-9-137-60**

**FERRIS-SMITH-KERRISON**

18 cm , 20 cm , 1mm,18 cm , 20 cm ,  
2mm,18 cm , 20 cm , 3mm,18 cm , 20 cm ,  
4mm,18 cm , 20 cm , 5mm,18 cm , 20 cm ,  
6mm,

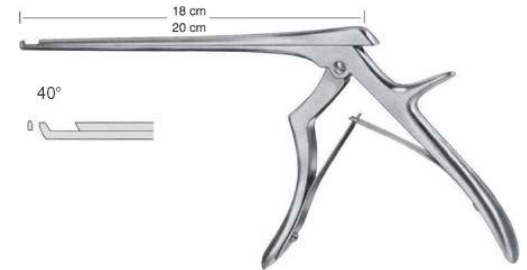

**FERRIS-SMITH-KERRISON**

**EF-9-137-61**

**FERRIS-SMITH-KERRISON**

18 cm , 20 cm , 1mm,18 cm , 20 cm ,  
2mm,18 cm , 20 cm , 3mm,18 cm , 20 cm ,  
4mm,18 cm , 20 cm , 5mm,18 cm , 20 cm ,  
6mm,

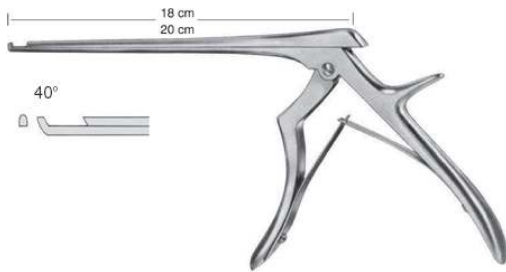

**FERRIS-SMITH-KERRISON**

**EF-9-137-62**

**FERRIS-SMITH-KERRISON**

18 cm , 20 cm , 1mm,18 cm , 20 cm ,  
2mm,18 cm , 20 cm , 3mm,18 cm , 20 cm ,  
4mm,18 cm , 20 cm , 5mm,18 cm , 20 cm ,  
6mm,

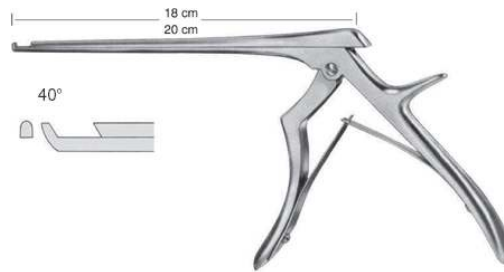

**FERRIS-SMITH-KERRISON**

**EF-9-137-63**

**FERRIS-SMITH-KERRISON**

18 cm , 20 cm , 1mm,18 cm , 20 cm ,  
2mm,18 cm , 20 cm , 3mm,18 cm , 20 cm ,  
4mm,18 cm , 20 cm , 5mm,18 cm , 20 cm ,  
6mm,

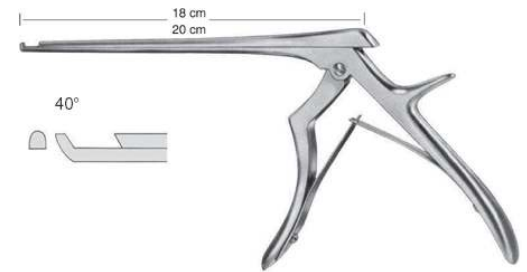

**FERRIS-SMITH-KERRISON**

**EF-9-137-64**

**FERRIS-SMITH-KERRISON**

18 cm , 20 cm , 1mm,18 cm , 20 cm ,  
2mm,18 cm , 20 cm , 3mm,18 cm , 20 cm ,  
4mm,18 cm , 20 cm , 5mm,18 cm , 20 cm ,  
6mm,

# Neurosurgery

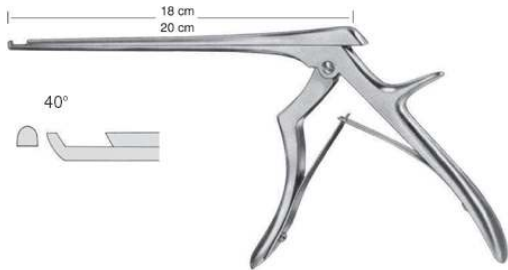

**FERRIS-SMITH-KERRISON**  
EF-9-137-65

**FERRIS-SMITH-KERRISON**  
18 cm , 20 cm , 1mm,18 cm , 20 cm ,  
2mm,18 cm , 20 cm , 3mm,18 cm , 20 cm ,  
4mm,18 cm , 20 cm , 5mm,18 cm , 20 cm ,  
6mm,

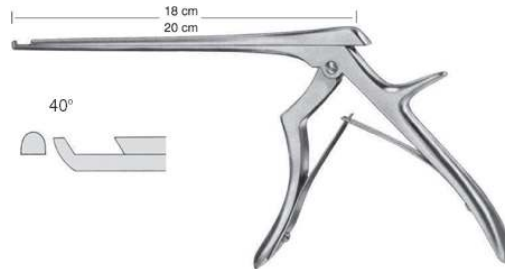

**FERRIS-SMITH-KERRISON**  
EF-9-137-66

**FERRIS-SMITH-KERRISON**  
18 cm , 20 cm , 1mm,18 cm , 20 cm ,  
2mm,18 cm , 20 cm , 3mm,18 cm , 20 cm ,  
4mm,18 cm , 20 cm , 5mm,18 cm , 20 cm ,  
6mm,

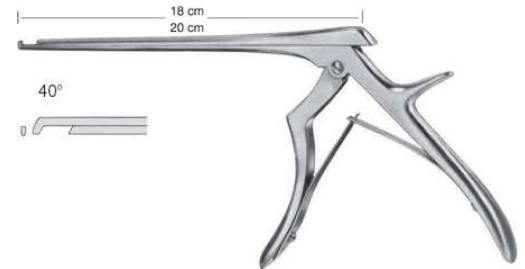

**FERRIS-SMITH-KERRISON**  
EF-9-137-67

**FERRIS-SMITH-KERRISON**  
18 cm , 20 cm , 1mm,18 cm , 20 cm ,  
2mm,18 cm , 20 cm , 3mm,18 cm , 20 cm ,  
4mm,18 cm , 20 cm , 5mm,18 cm , 20 cm ,  
6mm,

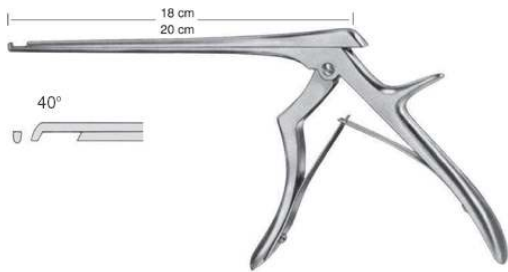

**FERRIS-SMITH-KERRISON**  
EF-9-137-68

**FERRIS-SMITH-KERRISON**  
18 cm , 20 cm , 1mm,18 cm , 20 cm ,  
2mm,18 cm , 20 cm , 3mm,18 cm , 20 cm ,  
4mm,18 cm , 20 cm , 5mm,18 cm , 20 cm ,  
6mm,

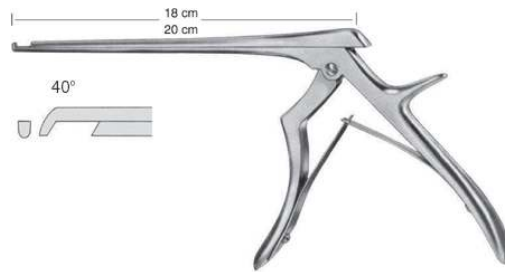

**FERRIS-SMITH-KERRISON**  
EF-9-137-69

**FERRIS-SMITH-KERRISON**  
18 cm , 20 cm , 1mm,18 cm , 20 cm ,  
2mm,18 cm , 20 cm , 3mm,18 cm , 20 cm ,  
4mm,18 cm , 20 cm , 5mm,18 cm , 20 cm ,  
6mm,

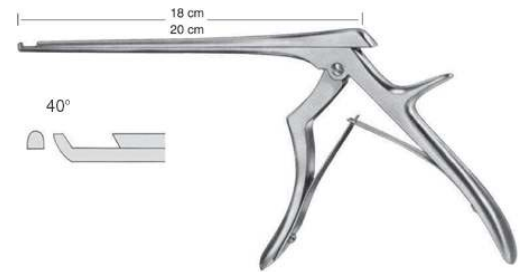

**FERRIS-SMITH-KERRISON**  
EF-9-137-70

**FERRIS-SMITH-KERRISON**  
18 cm , 20 cm , 1mm,18 cm , 20 cm ,  
2mm,18 cm , 20 cm , 3mm,18 cm , 20 cm ,  
4mm,18 cm , 20 cm , 5mm,18 cm , 20 cm ,  
6mm,

# Neurosurgery

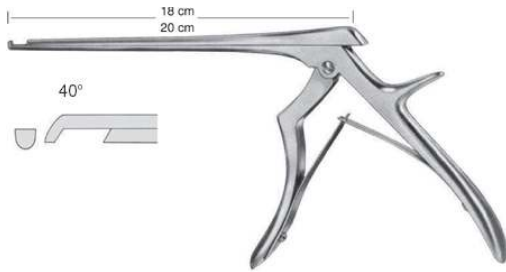

**FERRIS-SMITH-KERRISON**  
EF-9-137-71

**FERRIS-SMITH-KERRISON**  
18 cm , 20 cm , 1mm,18 cm , 20 cm ,  
2mm,18 cm , 20 cm , 3mm,18 cm , 20 cm ,  
4mm,18 cm , 20 cm , 5mm,18 cm , 20 cm ,  
6mm,

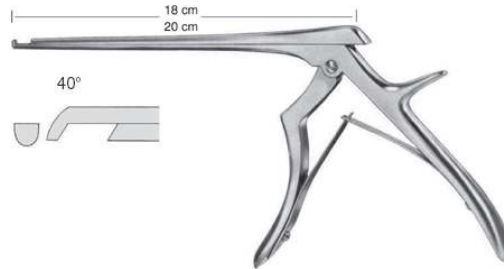

**FERRIS-SMITH-KERRISON**  
EF-9-137-72

**FERRIS-SMITH-KERRISON**  
18 cm , 20 cm , 1mm,18 cm , 20 cm ,  
2mm,18 cm , 20 cm , 3mm,18 cm , 20 cm ,  
4mm,18 cm , 20 cm , 5mm,18 cm , 20 cm ,  
6mm,

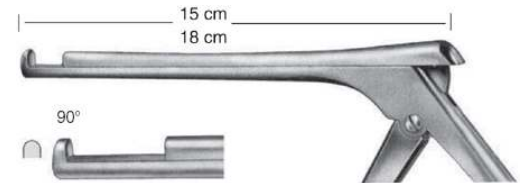

**COLCLOUGH**  
EF-9-137-73

**COLCLOUGH**  
3 mm  
5 mm  
  
15 cm,18 cm,

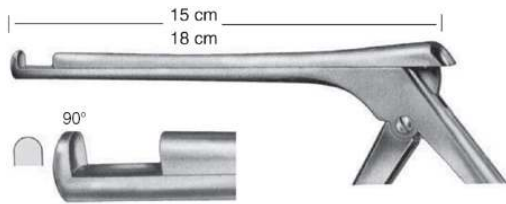

**COLCLOUGH**  
EF-9-137-74  
**COLCLOUGH**  
3 mm  
5 mm  
15 cm,18 cm,

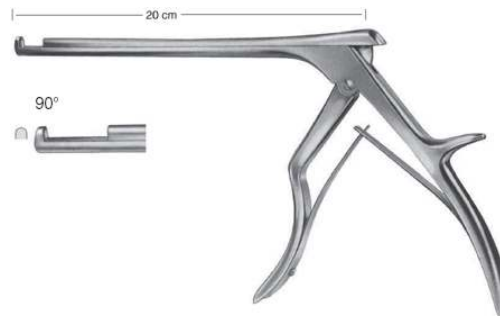

**COLCLOUGH**  
EF-9-137-75  
**COLCLOUGH**  
3 mm  
5 mm  
20 cm,

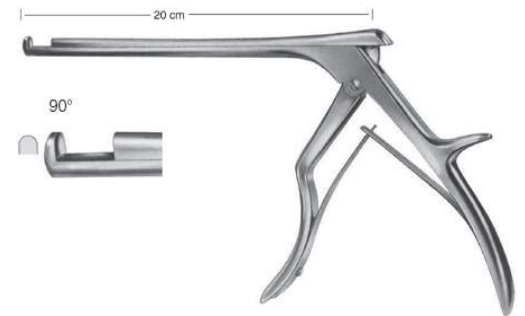

**COLCLOUGH**  
EF-9-137-76  
**COLCLOUGH**  
3 mm  
5 mm  
20 cm,

# Neurosurgery

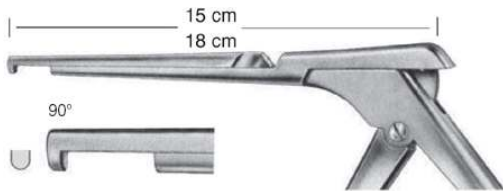

COLCLOUGH  
EF-9-137-77  
COLCLOUGH  
3 mm  
5 mm  
15 cm, 18 cm,

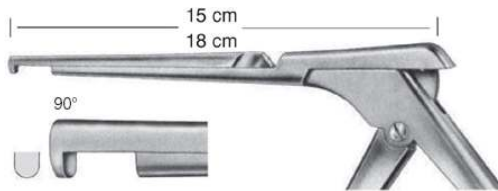

COLCLOUGH  
EF-9-137-78  
COLCLOUGH  
3 mm  
5 mm  
15 cm, 18 cm,

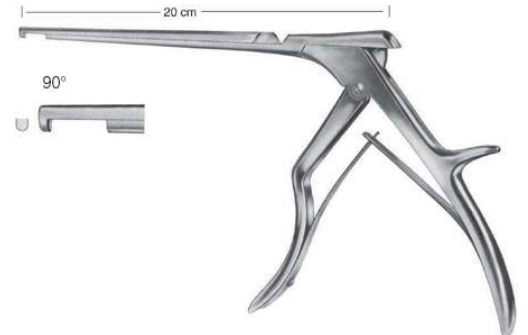

COLCLOUGH  
EF-9-137-79  
COLCLOUGH  
3 mm  
5 mm  
20 cm,

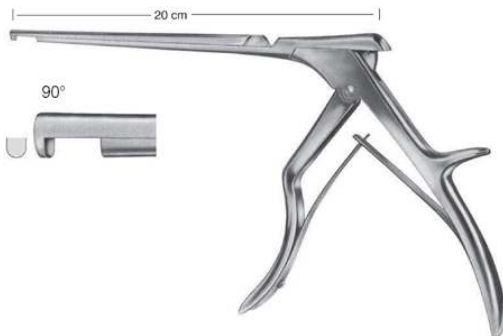

COLCLOUGH  
EF-9-137-80  
COLCLOUGH  
3 mm  
5 mm  
20 cm,



COLCLOUGH  
EF-9-137-81  
COLCLOUGH  
3 mm  
5 mm  
15 cm, 18 cm,

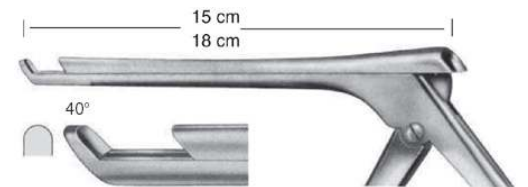

COLCLOUGH  
EF-9-137-82  
COLCLOUGH  
3 mm  
5 mm  
15 cm, 18 cm,

# Neurosurgery

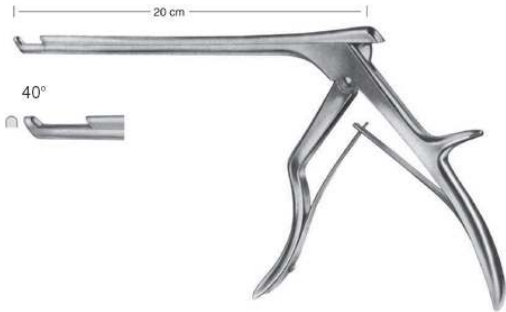

COLCLOUGH  
EF-9-137-83  
COLCLOUGH  
3 mm  
5 mm  
20 cm,

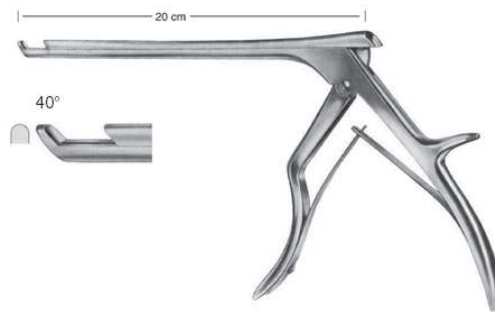

COLCLOUGH  
EF-9-137-84  
COLCLOUGH  
3 mm  
5 mm  
20 cm,

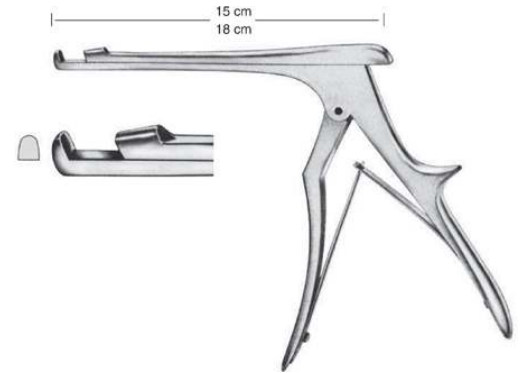

RANEY  
EF-9-137-85  
RANEY  
15 cm / 6mm, 18 cm / 6mm,

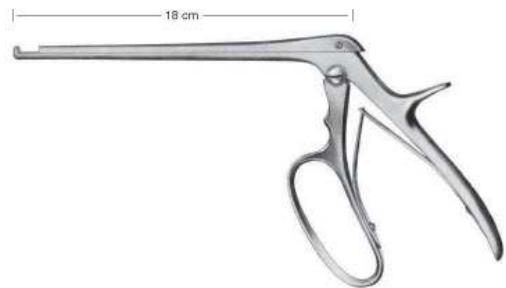

FERRIS-SMITH-KERRISON  
EF-9-137-86  
FERRIS-SMITH-KERRISON  
18 cm,

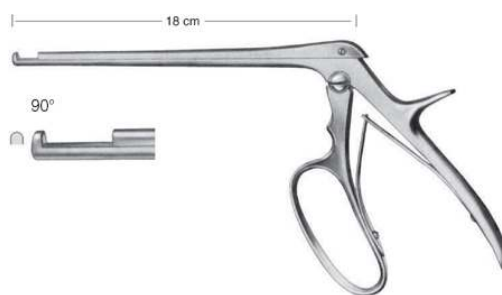

FERRIS-SMITH-KERRISON  
EF-9-137-87  
FERRIS-SMITH-KERRISON  
3x3 mm,

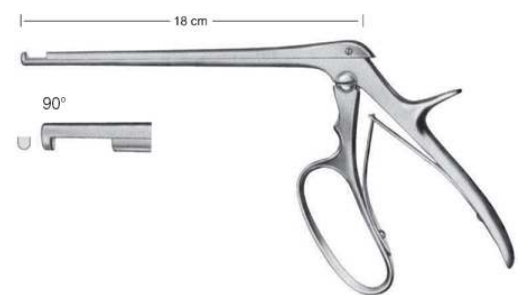

FERRIS-SMITH-KERRISON  
EF-9-137-88  
FERRIS-SMITH-KERRISON  
3x3 mm,

# Neurosurgery

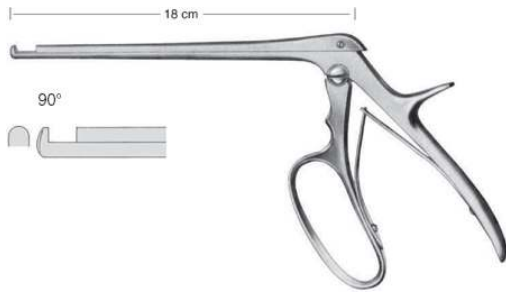

FERRIS-SMITH-KERRISON  
EF-9-137-89  
FERRIS-SMITH-KERRISON  
5x5 mm,

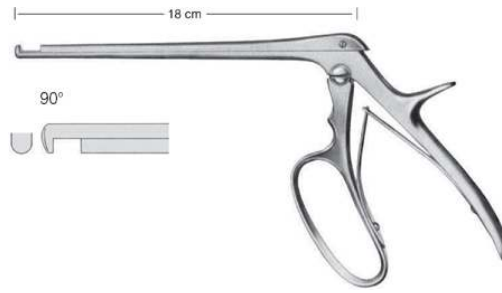

FERRIS-SMITH-KERRISON  
EF-9-137-90  
FERRIS-SMITH-KERRISON  
5x5 mm,

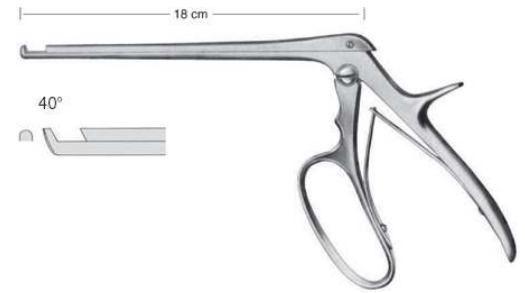

FERRIS-SMITH-KERRISON  
EF-9-137-91  
FERRIS-SMITH-KERRISON  
3 mm,

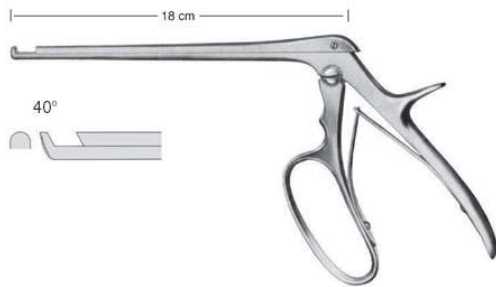

FERRIS-SMITH-KERRISON  
EF-9-137-92  
FERRIS-SMITH-KERRISON  
5 mm,

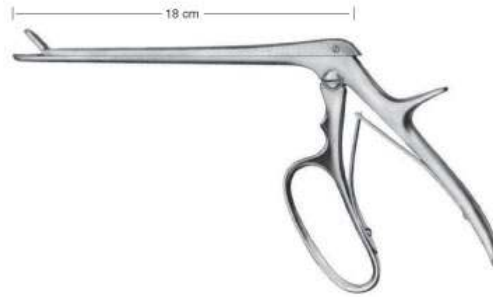

FERRIS-SMITH-CUSHING  
EF-9-137-93  
FERRIS-SMITH-CUSHING  
18 cm,

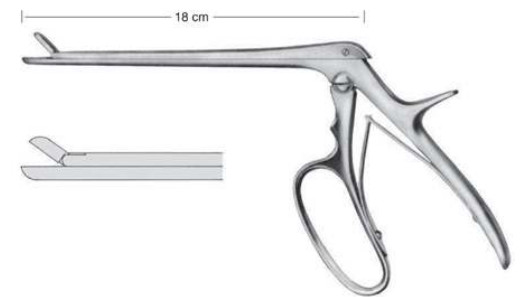

FERRIS-SMITH-CUSHING  
EF-9-137-94  
FERRIS-SMITH-CUSHING  
2 x 10 mm, 3 x 10 mm, 4 x 10 mm, 5 x 10 mm, 6 x 10 mm,

# Neurosurgery

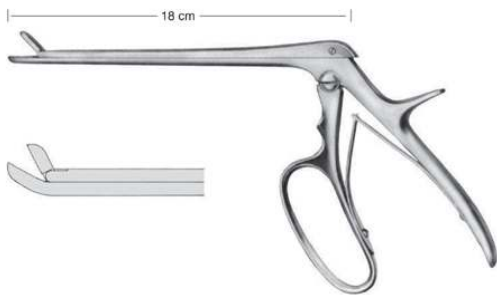

**FERRIS-SMITH-CUSHING**

EF-9-137-95

**FERRIS-SMITH-CUSHING**

2 x 10 mm, 3 x 10 mm, 4 x 10 mm, 5 x 10 mm, 6 x 10 mm,

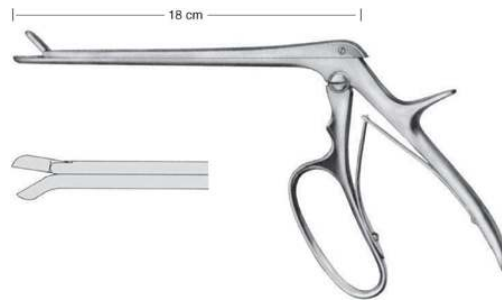

**FERRIS-SMITH-CUSHING**

EF-9-137-96

**FERRIS-SMITH-CUSHING**

2 x 10 mm, 3 x 10 mm, 4 x 10 mm, 5 x 10 mm, 6 x 10 mm,

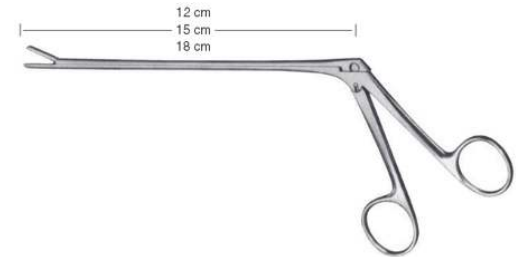

**CUSHING**

EF-9-137-97

**CUSHING**

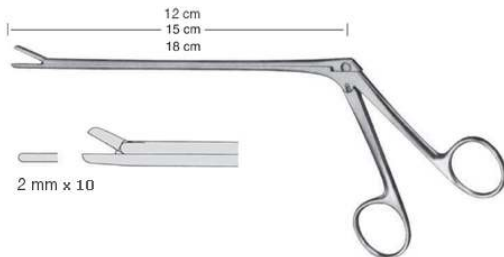

**CUSHING**

EF-9-137-98

**CUSHING**

2 mm x 10, 12 cm, 15 cm, 18 cm,

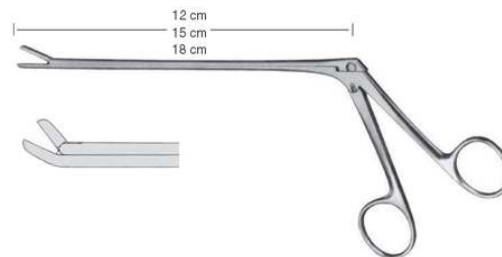

**CUSHING**

EF-9-137-99

**CUSHING**

2 mm x 10, 12 cm, 15 cm, 18 cm,

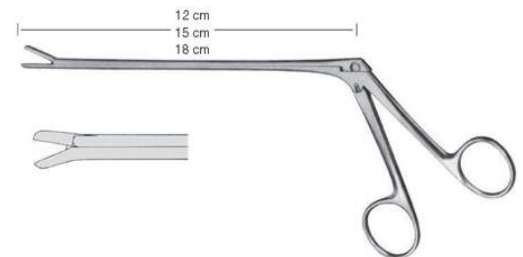

**CUSHING**

EF-9-137-100

**CUSHING**

2 mm x 10, 12 cm, 15 cm, 18 cm,



# Neurosurgery

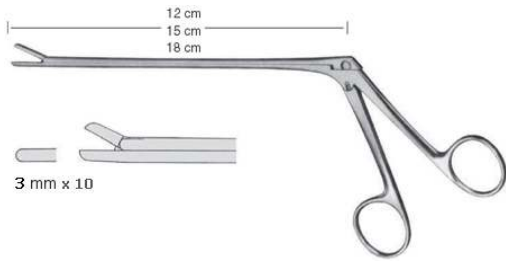

LOVE-GRUENWALD  
EF-9-137-101  
LOVE-GRUENWALD  
3 mm x 10,12 cm,15 cm,18 cm,

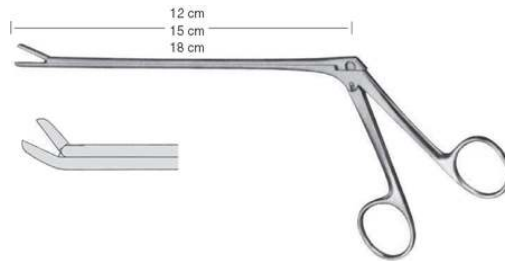

LOVE-GRUENWALD  
EF-9-137-102  
LOVE-GRUENWALD  
3 mm x 10,12 cm,15 cm,18 cm,

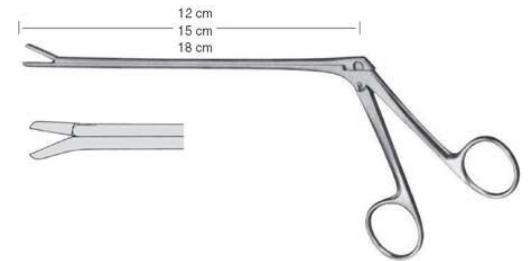

LOVE-GRUENWALD  
EF-9-137-103  
LOVE-GRUENWALD  
3 mm x 10,12 cm,15 cm,18 cm,

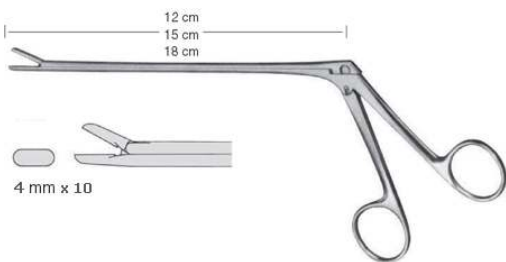

SPURLING  
EF-9-137-104  
SPURLING  
4 mm x 10,12 cm,15 cm,18 cm,

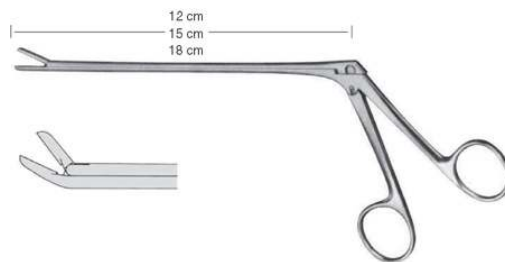

SPURLING  
EF-9-137-105  
SPURLING  
4 mm x 10,12 cm,15 cm,18 cm,



SPURLING  
EF-9-137-106  
SPURLING  
4 mm x 10,12 cm,15 cm,18 cm,

# Neurosurgery



OLDAMZRG  
EF-9-137-107  
OLDAMZRG  
18 cm,



SCHLESINGER  
EF-9-137-108  
SCHLESINGER  
15 cm, 2 x 10 mm, 3 x 10 mm, 4 x 10 mm, 5 x 10 mm,



CAMZPAR  
EF-9-137-109  
CAMZPAR  
2 mm, 14 cm, 15 cm, 16 cm, 18.5 cm,



CAMZPAR  
EF-9-137-110  
CAMZPAR  
3 mm, 14 cm, 15 cm, 16 cm, 18.5 cm,



CAMZPAR  
EF-9-137-111  
CAMZPAR  
4 mm, 14 cm, 15 cm, 16 cm, 18.5 cm,



CAMZPAR  
EF-9-137-112  
CAMZPAR  
5 mm, 14 cm, 15 cm, 16 cm, 18.5 cm,

# Neurosurgery



CAMZPAR  
EF-9-137-113  
CAMZPAR  
2 mm, 14 cm, 15 cm, 16 cm, 18.5 cm,



CAMZPAR  
EF-9-137-114  
CAMZPAR  
3 mm, 14 cm, 15 cm, 16 cm, 18.5 cm,



CAMZPAR  
EF-9-137-115  
CAMZPAR  
4 mm, 14 cm, 15 cm, 16 cm, 18.5 cm,



CAMZPAR  
EF-9-137-116  
CAMZPAR  
2 mm, 14 cm, 15 cm, 16 cm, 18.5 cm,



CAMZPAR  
EF-9-137-117  
CAMZPAR  
3 mm, 14 cm, 15 cm, 16 cm, 18.5 cm,



CAMZPAR  
EF-9-137-118  
CAMZPAR  
4 mm, 14 cm, 15 cm, 16 cm, 18.5 cm,

## Neurosurgery



YAMZARGIL  
EF-9-137-119  
YAMZARGIL  
25 cm, 2.2 cm, 3.5 cm, 4.0 cm,



LANDOLT  
EF-9-137-120  
LANDOLT  
27 cm, 9 mm,



OLIVECRONA-TOENNIS  
EF-9-137-121  
14 cm,

## Cardiovascular



EF-9-101-23  
Bone Shear  
23 cm,



EF-9-102-22  
Rib Shear  
23 cm,



Gluck  
EF-9-103-22  
Rib Shears  
21 cm,



Giertz-Stille  
EF-9-104-27  
Rib Shear  
24.5 cm,



Lebsche  
EF-9-105-24  
Sternum Chisel  
24.5 cm,



EF-9-106-01  
Rib Retractor lateral blades 12 x 16 mm  
spreading 95 mm  
Size 1,

# Cardiovascular



Finochietto, Infant  
EF-9-107-01

Rib Retractor lateral blades 15 x 15 mm  
spreading 75 mm  
Size 1,



Finochietto, Baby  
EF-9-108-01

Rib Retractor lateral blades 31 x 31 mm  
spreading 100 mm  
Size 1,



Finochietto  
EF-9-109-01

Rib Retractor lateral blades 40 x 45 mm  
spreading 135 mm  
Size 1,



Burford  
EF-9-110-01

Rib Retractor with two pairs of blades 47 x 62 mm + 65 x 62 mm, spreading 200 mm  
Size 1,



Castaneda  
EF-9-111-01

Rib Retractor lateral blades 10,5 x 32 mm  
spreading 65 mm  
Size 1,



Finochietto (modif.)  
EF-9-112-01

Rib Retractor lateral blades 14 x 15 mm  
spreading 120 mm  
Size 1,



Haight  
EF-9-113-90  
Rib Retractor lateral blades 30 x 30 mm  
spreading 120 mm  
Size 1,



Morse-Favaloro  
EF-9-114-01  
Sternal Retractor 4 movable blades 17 x 22  
mm spreading 160 mm Sternal Retractor  
Size 1,



Morse  
EF-9-115-00  
Sternal Retractor 4 movable blades 22 x 27  
mm spreading 200 mm  
Size 1,



Tuffier  
EF-9-116-02  
Rib Retractor lateral blades 22 x 27 mm  
spreading 200 mm  
Size 1,

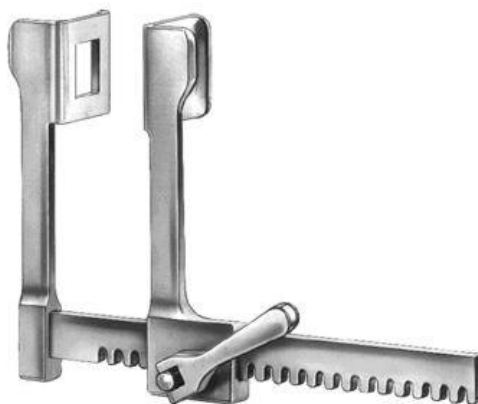

Finochietto, Baby  
EF-9-117-75  
Rib Retractor lateral blades 14 x 15 mm  
spreading 75 mm  
Size 1,

# Cardiovascular



DeBakey  
EF-9-119-00  
Rib Retractor spreading 150 mm  
Size 1,



DeBakey  
EF-9-120-00  
Rib Retractor spreading 200 mm  
Size 1,



EF-9-121-00  
Thoracic Retractor  
Size 1,



Sellors  
EF-9-122-19  
Rib Contractor  
20 cm,



Bailey-Baby  
EF-9-123-14  
Rib Contractor  
15.5 cm,



Bailey  
EF-9-124-16  
Rib Contractor  
20 cm,



# Cardiovascular



**Bailey-Gibbon**  
EF-9-125-16  
Rib Contractor  
20 cm,



**Allison**  
EF-9-126-30  
Lung Spatula  
29.5 cm, 32.5 cm,



**Price-Thomas**  
EF-9-127-22  
Bronchus Clamp  
22 cm,

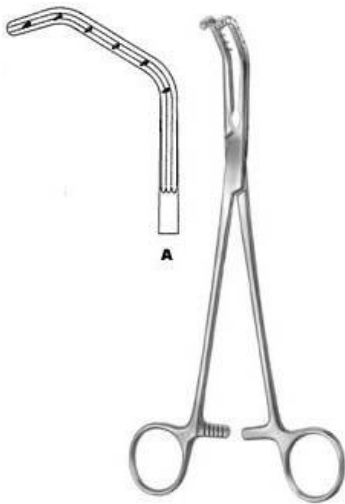

**Price-Thomas**  
EF-9-128-22  
Bronchus Clamp  
22 cm,

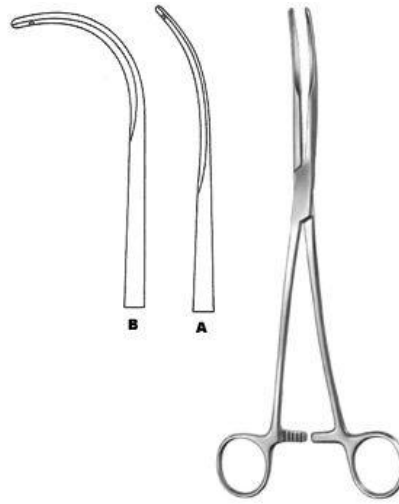

**Semb**  
EF-9-129-24  
Bronchus Clamp  
24.5 cm,

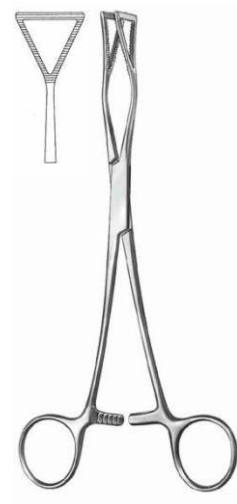

**Lovlace**  
EF-9-130-20  
Lung Grasping Forceps  
20.5 cm,



Lovelace  
EF-9-131-20  
Lung Grasping Forceps  
19 cm,

# Cardiovascular



**DeBakey-Rankin**  
**EF-9-137-16**  
**Haemostatic Forceps**  
 16 cm,



**DeBakey-Mosquito**  
**EF-9-138-15**  
**Haemostatic Forceps**  
 15 cm,



**Ochsner**  
**EF-9-139-23**  
**Aortic Clamp**  
 23.5 cm,



**Diethrich**  
**EF-9-140-21**  
**Aortic Clamp**  
 22 cm,

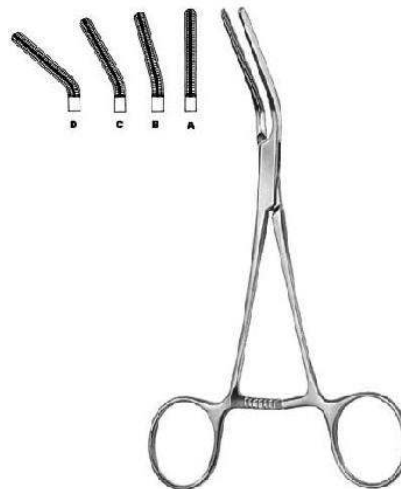

**Dardik**  
**EF-9-141-00**  
**Multi purpose Vascular Clamp**  
 15 cm,



**Dale**  
**EF-9-142-18**  
**Peripheral Vascular Clamp**  
 18 cm,

# Cardiovascular

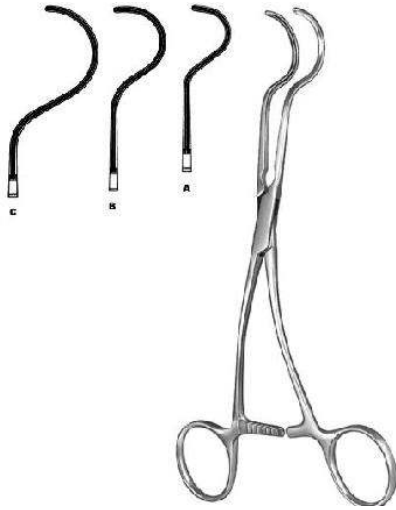

**Dale**  
 EF-9-143-17  
 Peripheral Vascular Clamp  
 17.5 cm,

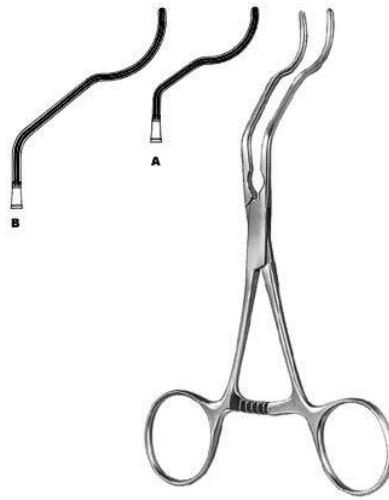

**Gregory**  
 EF-9-144-14  
 Profunda Clamp  
 13 cm, 16 cm, 18 cm,



**Martin**  
 EF-9-145-16  
 Peripheral Vascular Clamp  
 16.5 cm,



**Husfeldt**  
 EF-9-146-18  
 Peripheral Vascular Clamp  
 17.5 cm,



**Husfeldt**  
 EF-9-147-18  
 Peripheral Vascular Clamp  
 18 cm,



**Husfeldt**  
 EF-9-148-17  
 Peripheral Vascular Clamp  
 17 cm,



DeBakey  
EF-9-149-16  
Vascular Forceps  
16 cm,



DeBakey  
EF-9-150-16  
Vascular Forceps  
16 cm,



DeBakey  
EF-9-151-16  
Vascular Forceps  
16 cm,



DeBakey  
EF-9-152-16  
Vascular Forceps  
16 cm,



DeBakey  
EF-9-153-16  
Vascular Forceps  
16 cm,



DeBakey  
EF-9-154-07  
Bulldog Clamp  
7.5 cm,

# Cardiovascular



DeBakey  
EF-9-155-07  
Bulldog Clamp  
7.5 cm,



EF-9-156-23  
Applying Forceps  
23.5 cm,



Glover  
EF-9-157-06  
Bulldog Clamp  
7 cm,



Glover  
EF-9-158-06  
Bulldog Clamp  
6.5 cm,

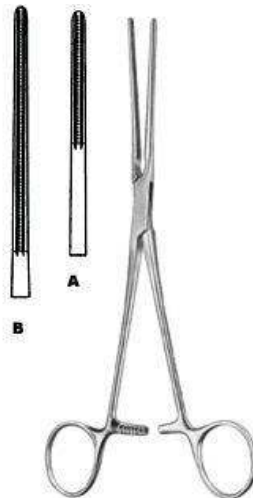

Potts  
EF-9-159-21  
Coarctation Clamp  
21 cm,

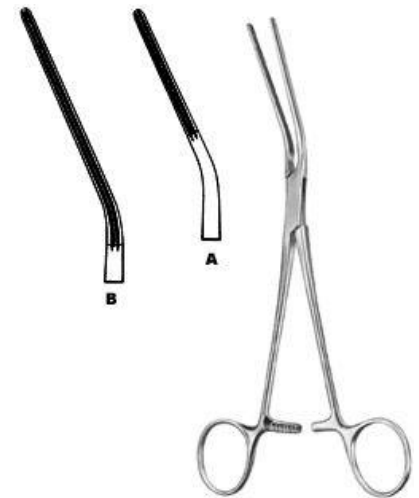

Potts  
EF-9-160-21  
Coarctation Clamp  
20.5 cm,

# Cardiovascular

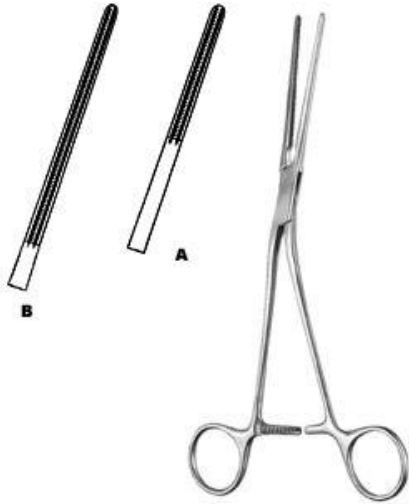

Potts  
EF-9-161-21  
Coarctation Clamp  
20.5 cm,



Potts  
EF-9-162-22  
Anastomosis Clamp  
21.5 cm,



Potts  
EF-9-163-22  
Anastomosis Clamp  
22 cm,

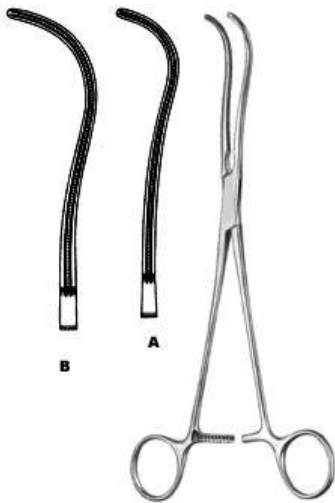

DeBakey  
EF-9-164-19  
Ligature Forceps  
19 cm,



DeBakey  
EF-9-165-16  
Peripheral Vascular Clamp  
16 cm,



DeBakey  
EF-9-166-19  
Peripheral Vascular Clamp  
16 cm,

# Cardiovascular

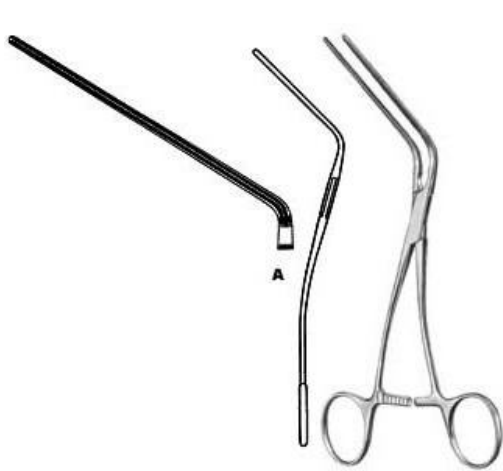

Leland-Jones  
EF-9-167-18  
Peripheral Vascular Clamp  
18 cm,



Bainbridge  
EF-9-168-15  
Multi purpose Vascular Clamp  
15 cm,



Bainbridge  
EF-9-169-15  
Multi purpose Vascular Clamp  
15 cm,

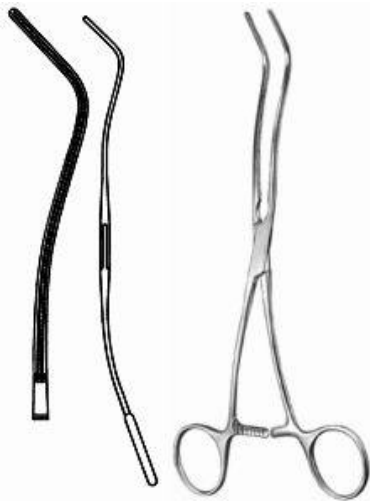

DeBakey  
EF-9-170-20  
Multi purpose Vascular Clamp  
20 cm,



DeBakey  
EF-9-171-26  
Aortic Aneurysm Clamp  
26 cm,



DeBakey  
EF-9-172-28  
Aortic Aneurysm Clamp  
28 cm,





# Cardiovascular



Satinsky  
EF-9-180-20  
Tangential Occlusion Clamp  
22 cm,



Harken  
EF-9-181-01  
Auricle Clamp  
24.5 cm,



Lees  
EF-9-182-23  
Bronchus Clamp  
23 cm,



Lees  
EF-9-183-25  
Bronchus Clamp  
25 cm,



Lambert-Kay  
EF-9-184-21  
Anastomosis Clamp  
22.5 cm,



DeBakey  
EF-9-185-17  
Anastomosis Clamp  
16.5 cm,

# Cardiovascular



**Morris-DeBakey**  
**EF-9-186-18**  
**Aortic Clamp**  
 16.5 cm,



**DeBakey-Bahnson**  
**EF-9-187-23**  
**Aneurysm Clamp**  
 23.5 cm,

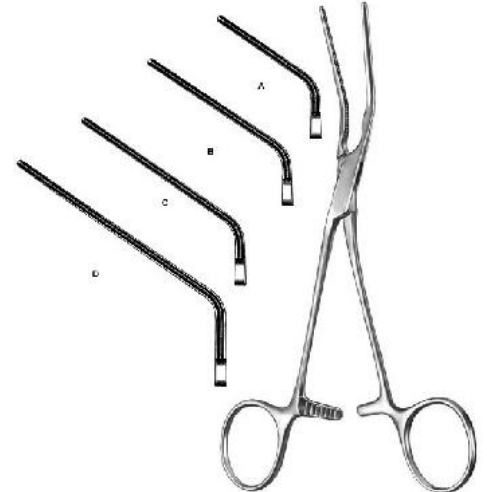

**DeBakey**  
**EF-9-188-20**  
**Multi purpose Vascular Clamp**  
 18 cm,

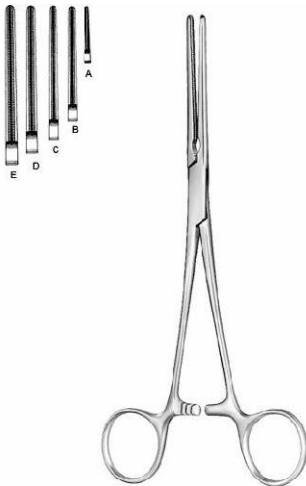

**DeBakey-Mosquito**  
**EF-9-189-12**  
**Haemostatic Forceps**  
 12.5 cm,

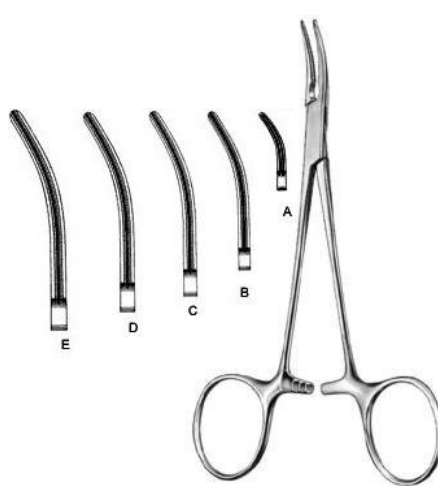

**DeBakey-Mosquito**  
**EF-9-190-12**  
**Haemostatic Forceps**  
 12.5 cm,



**DeBakey**  
**EF-9-191-17**  
**Multi purpose Vascular Clamp**  
 17 cm,



DeBakey  
EF-9-192-16  
Multi purpose Vascular Clamp  
16.5 cm,

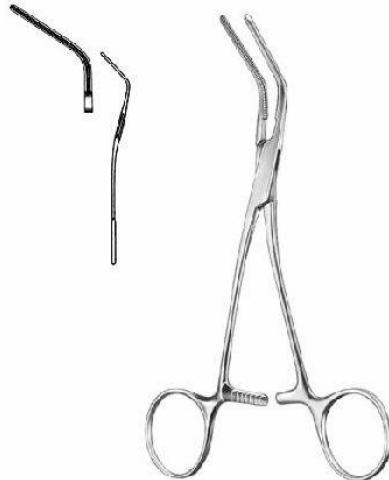

DeBakey  
EF-9-193-15  
Multi purpose Vascular Clamp  
16 cm,

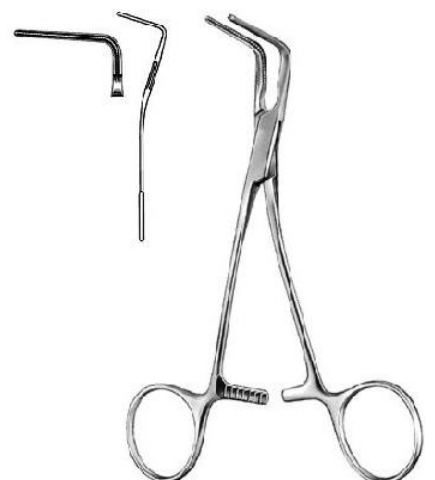

DeBakey  
EF-9-194-15  
Multi purpose Vascular Clamp  
16.5 cm,

# Cardiovascular

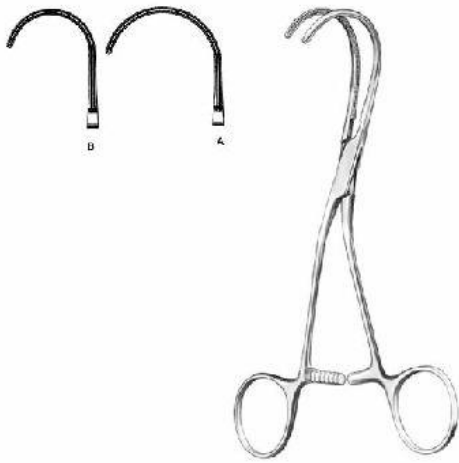

**DeBakey**  
**EF-9-198-16**  
 Multi purpose Vascular Clamp  
 16.5 cm,

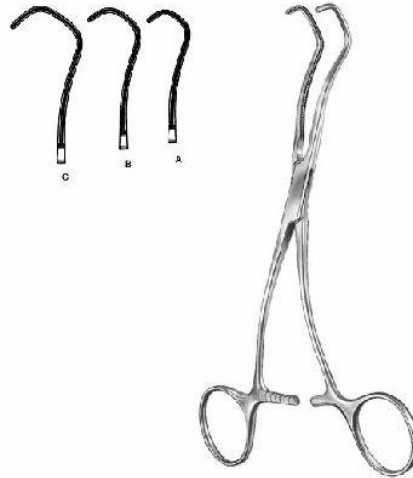

**Derra**  
**EF-9-199-16**  
 Anastomosis Clamp  
 16.5 cm Fig. 1, 17 cm Fig. 2, 18 cm Fig. 3,



**DeBakey-Beck**  
**EF-9-200-17**  
 Anastomosis Clamp  
 17 cm,



**Cooley**  
**EF-9-201-16**  
 Vascular Forceps  
 16 cm,

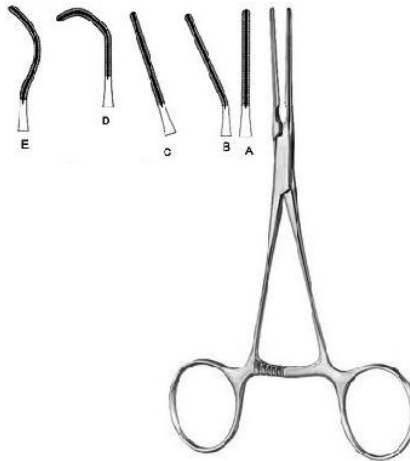

**Cooley**  
**EF-9-202-01**  
 Pediatric Vascular Clamp  
 14.5 cm,



**Cooley**  
**EF-9-203-21**  
 Iliac Clamp  
 22 cm,

# Cardiovascular

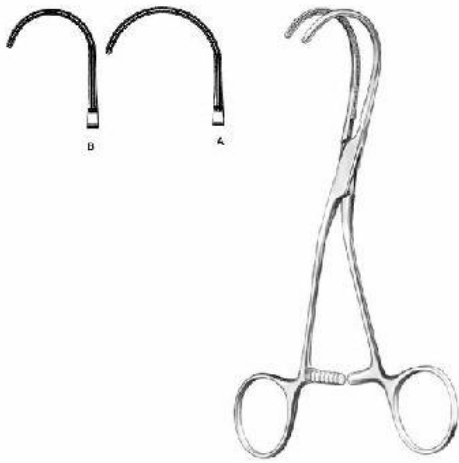

**DeBakey**  
**EF-9-198-16**  
 Multi purpose Vascular Clamp  
 16.5 cm,

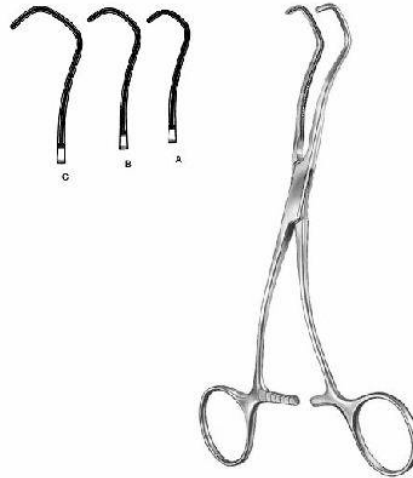

**Derra**  
**EF-9-199-16**  
 Anastomosis Clamp  
 16.5 cm Fig. 1, 17 cm Fig. 2, 18 cm Fig. 3,



**DeBakey-Beck**  
**EF-9-200-17**  
 Anastomosis Clamp  
 17 cm,



**Cooley**  
**EF-9-201-16**  
 Vascular Forceps  
 16 cm,

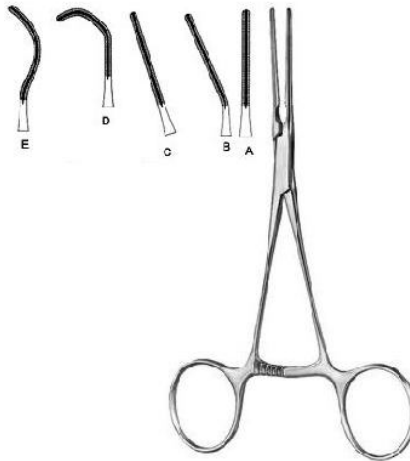

**Cooley**  
**EF-9-202-01**  
 Pediatric Vascular Clamp  
 14.5 cm,



**Cooley**  
**EF-9-203-21**  
 Iliac Clamp  
 22 cm,

# Cardiovascular



Cooley  
EF-9-204-17  
Anastomosis Clamp  
17 cm,

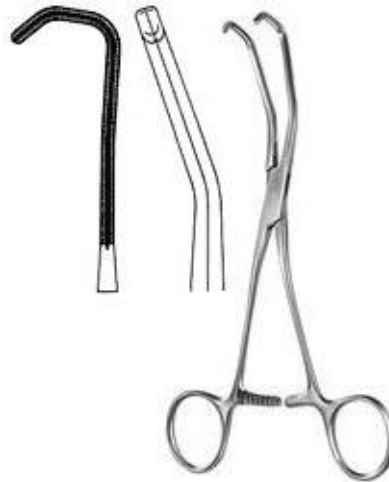

Cooley  
EF-9-205-17  
Anastomosis Clamp  
20 cm,



Cooley  
EF-9-206-16  
Anastomosis Clamp  
17 cm,



Cooley  
EF-9-207-15  
Multi purpose Vascular Clamp  
16 cm,



Cooley  
EF-9-208-17  
Multi purpose Vascular Clamp  
17 cm,



Cooley  
EF-9-209-17  
Multi purpose Vascular Clamp  
17 cm,

# Cardiovascular



Cooley  
EF-9-210-17  
Multi purpose Vascular Clamp  
17.5 cm,

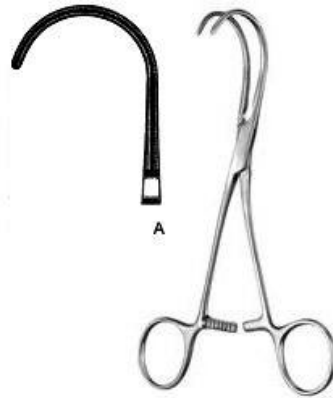

Cooley  
EF-9-211-16  
Multi purpose Vascular Clamp  
16.5 cm,



Cooley-Derra  
EF-9-212-16  
Anastomosis Clamp  
16.5 cm,



Cooley-Beck  
EF-9-213-17  
Anastomosis Clamp  
17 cm,

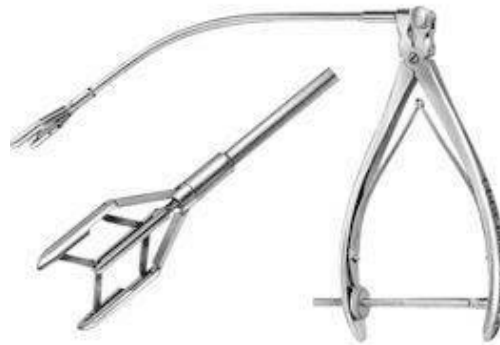

Cooley  
EF-9-214-00  
Aortic Dilator



Cooley  
EF-9-215-05  
Vascular Dilator  
13 cm 0,5 mm ?,





## Hospital Uniforms



EF-9-216-06  
Doctor Uniform



EF-9-217-01  
Lab coats



EF-9-218-02  
Surgical gowns



EF-9-219-18  
Patient Gowns



EF-9-220-01  
Scrub Suit



EF-9-221-20  
Nurse Uniform

## Hospital Bed Sheet



EF-9-216-06  
Bed Sheet



EF-9-217-01  
Bed Linen



EF-9-217-04  
Bed Linen



EF-9-217-06  
Hospital Bed Sheet

## Hospital Towels



EF-9-216-06  
Hospital Towels



EF-9-216-08  
Hospital Towels



EF-9-217-09  
Hospital Towels



+92 348 6231107



+92 348 6231107



info@elifitstruments.com



elifitstruments@gmail.com



www.elifitstruments.com



Street 36/34, Defence Road, Industrial  
Area Zone, Sialkot